



---

## Instruction Manual PSx3xx-PN

---



halstrup-walcher GmbH

Stegener Straße 10  
D-79199 Kirchzarten

Phone: +49 (0) 76 61/39 63-0

E-Mail: [info@halstrup-walcher.com](mailto:info@halstrup-walcher.com)  
Internet: [www.halstrup-walcher.com](http://www.halstrup-walcher.com)

## Overview

Version:	Date:	Author:	Content:
A		Re	Initial Revision
B	01.08.14	Me	safety position
C	16.02.15	Me	Additions PSS/PSW; drawings
D	11.11.16	Me	Declaration of conformity
E	08.02.17	Me	Pin assignment
F	07.03.17	Re	IRT/RT-mode
G	17.03.17	Me	Diameter of the output shaft + drawings
H	29.01.18	Ka	NRTL
I	08.11.18	Me	Standardisation of PSx-manuals
J	12.12.18	Me	missing parameters added
K	19.03.19	Me	Fuses
L	28.06.19	Ka	scaling factors to set the spindle pitch
M	19.07.19	Me	Pin assignment
N	03.12.19	Me	2xY-cod; PSE338-14
O	12.03.20	Me	PSW3218+PSW3318 added
P	29.09.20	Me	Additions process-data
Q	25.01.21	Me	Connection timeout
R	17.01.22	Me	Revision overview; Pin assignment; Error Acknowledge; Readjustment; Referencing value; Mapping end; Manual turning; UKCA
S	26.09.22	Me	2.9.2 Table of parameters; 4.14 Image PSE34xx 5.2 Power consumption
T	08.08.23	Ts	revise manual, QR code measurement technology, current consumption "Electrical data" corrected. New chapter Limitation of liability and cross-sections Power supply cable. Reference to axial and radial forces in chap. assembly.
U	19.06.24	Ts	Error corrections, safety topics, meaning of the operating instructions revised, intended and non-intended use added, limitation of liability revised, new product labeling, assembly chapter revised, vibration and noise emissions in Physical Data added, Plug colour designation removed

Translation of the original instructions

© **2024**

The manufacturer owns the copyright to this instruction manual. It contains technical data, instructions and drawings detailing the devices' features and how to use them. It must not be copied either wholly or in part or made available to third parties. These operating instruction is part of the product. Read these instructions carefully, follow our instructions and pay particular attention to safety instructions. The instructions should be available at all times.

## Purpose of instruction manual

This instruction manual describes the features of the PSx3xx positioning system and provides guidelines for its use.

Every person who is tasked with carrying out work on or with the appliance must have read and understood the operating instructions before starting work on the appliance. This also applies if the person concerned has already worked with such an appliance or a similar appliance or has been trained by the manufacturer.

These appliances can pose a risk to persons and property due to improper use and incorrect operation. For this reason, every person entrusted with handling the appliances must be trained and aware of the dangers. The operating instruction and in particular the safety instruction contained therein must be carefully observed.

**Always contact the manufacturer if you do not understand any parts of these instructions.**

Handle these operating instructions with care:

- It must be kept within easy reach for the entire service life of the appliances.
- It must be passed on to subsequent personnel.
- Any supplements issued by the manufacturer must be included.

The manufacturer reserves the right to further develop this device type without documenting this in each individual case. Your manufacturer will be happy to provide you with information on the current status of these operating instructions.

## Conformity

This device is state of the art.

It complies with the statutory requirements of the EC and UK-directives. This is documented by the CE and the UKCA mark being affixed.



## Accessoires PSx3xx-CA series

We offer you the corresponding supply and data plugs for all unit types. Please contact our sales department, stating the complete type designation, at the following e-mail address

[Vertrieb@halstrup-walcher.de](mailto:Vertrieb@halstrup-walcher.de)

## Table of Contents

<b>Overview .....</b>	<b>2</b>
<b>1. Safety precautions .....</b>	<b>6</b>
1.1 Qualified personnel .....	6
1.2 Explanation of symbols .....	6
1.3 Appropriate use .....	7
1.4 Inappropriate use .....	8
1.5 Limitation of liability .....	9
1.6 Faults, maintenance, repair, disposal .....	9
1.7 Product labelling .....	10
<b>2. Device description .....</b>	<b>11</b>
2.1 Features .....	11
<b>3. Installation .....</b>	<b>12</b>
3.1 Electrical connection .....	12
3.2 Assembly of the positioning system .....	13
3.2.1 Hollow shaft .....	13
3.2.2 Solid shaft .....	15
3.3 Disassembly .....	15
3.4 Powering the device .....	16
3.5 Pin assignment .....	16
3.5.1 Supply voltage connector (24VDC) .....	16
3.5.2 Round socket for bus (Port1 and Port2) .....	17
3.5.3 One Hybrid bushing for supply and bus (Hybr) .....	17
3.5.4 Connector for jog keys (Jog) .....	17
3.5.5 Connector-option -2Y- .....	18
3.5.6 Electrical grounding (Chassis) .....	18
3.6 Setting of the device name .....	18
3.7 LEDs .....	19
3.8 Start-up .....	20
3.8.1 Positioning run .....	21
3.8.2 Manual run .....	22
3.8.3 Restoring the factory settings (without controller) .....	22
3.9 PROFINET interface .....	22
3.9.1 Table of implemented parameter entries .....	24
3.9.2 Table of rated speed and torque values for various models of gears .....	31
3.9.3 Structure of process data .....	34
3.9.4 Detailed description of the status bits .....	34
3.9.5 Detailed description of control bits .....	37
3.9.6 PKW parameter interface .....	38
<b>4. Sequence of positioning .....</b>	<b>41</b>
4.1 Positioning run (with loop) .....	41
4.2 Sequence of a positioning process without a loop .....	42
<b>5. Specials .....</b>	<b>43</b>
5.1 Speed, acceleration and deceleration .....	43
5.2 Maximum starting torque and maximum torque .....	43
5.3 Response of drive in case of block .....	43
5.4 Readjustment in case of manual displacement externally .....	44
5.5 Calculating the absolute physical position .....	44
5.6 Use of the "Upper mapping end" parameter .....	47
5.6.1 Delivery state .....	47
5.6.2 Shifting the positioning range upwards starting from the delivery state .....	48
5.6.3 Shifting the positioning range downwards starting from the delivery state .....	48
5.6.4 Shifting the positioning range depending on the actual position .....	50
5.6.5 Step-by-step instructions for determining the positioning range .....	51

5.7	Using position scaling factors to set the spindle pitch .....	53
5.8	Drag error monitoring .....	53
5.9	Drag error correction .....	53
5.10	Response at power up, at "IOPS = BAD" and at connection timeout .....	54
5.11	Devices with "Jog keys" option .....	55
5.12	Manual turning with the adjustment facility .....	56
5.13	Devices with optional snap brake .....	57
5.14	Devices with optional holding brake .....	57
5.15	Reference runs.....	58
5.16	Reverse drive .....	59
<b>6.</b>	<b>Technical Data.....</b>	<b>60</b>
6.1	Ambient conditions .....	60
6.2	Electrical data .....	60
6.3	Physical data.....	61
<b>7.</b>	<b>Certificates of Conformity .....</b>	<b>62</b>

## 1. Safety precautions

This section provides an overview of all the important safety aspects for optimum protection of personnel and for safe and trouble-free operation.

### 1.1 Qualified personnel

These operating instructions are intended for qualified electricians and fitters who are authorized to install, electrically connect, commission and label devices and systems in accordance with safety standards, as well as for the operator and manufacturer of the system on which the drives are installed.

The personnel must be provided with all applicable accident prevention and safety regulations that arise during commissioning or installation of the system.

It must be ensured that the personnel are familiar with all applicable accident prevention and safety regulations.

### 1.2 Explanation of symbols

In these operating instructions, the following highlights are used to draw attention to the hazards described below when handling the system:

<b>⚠ DANGER</b>	<b>DANGER!</b> Indicates a situation of imminent danger, which will lead to a fatality or serious injuries if not prevented.
<b>⚠ WARNING</b>	<b>WARNING!</b> Indicates a potentially dangerous situation, which may lead to a fatality or serious injuries if not prevented.
<b>⚠ CAUTION</b>	<b>CAUTION!</b> Indicates a potentially dangerous situation, which may lead to minor/slight injuries if not prevented.
<b>NOTICE</b>	<b>NOTICE</b> Indicates a potentially harmful situation, which may lead to material damage if not prevented.

### 1.3 Appropriate use

Positioning systems are especially suitable for automatically setting tools, stops or spindles for wood-processing equipment, packing lines, printing equipment, filling units and other types of special machines.

PSx3xx positioning systems are not stand-alone devices and may only be used if coupled to another machine.



#### WARNING

Personal injury and property damage due to incorrect use of the products!

The positioning systems are designed for use in an industrial environment and may only be used as intended. If they are not used as intended, situations may arise that result in damage to property and personal injury.

#### NOTICE

The device is used as intended if all instructions and information in these operating instructions are observed.

- Only operate the device in perfect technical condition
- When attaching to a machine, observe the current safety regulations.
- Do not operate the product in all installed state unless all necessary protective measures have been taken.
- Observe the relevant regulations for the prevention of accidents (e.g. accident prevention regulations).
- In order to avoid the risk of accidents due to contact with moving parts, appropriate separating or non-separating guards must be provided.
- Use appropriate protective equipment (e.g. safety helmet, safety goggles, safety shoes, protective gloves).
- Use appropriate assembly and transport equipment.
- Store and transport the product in its original packaging, reuse protective caps for plugs if necessary.
- Adequate ventilation must be provided at the point of use to avoid excessive heating.
- During project planning, ensure that the device is always operated within its specifications. See technical data in chapter 6. Technical Data.
- If the device is equipped with a brake, it is not a safety brake that may be used for safety functions.
- In special areas of application such as the chemical, pharmaceutical or food sector, the positioning system in stainless steel design is possible.

## 1.4 Inappropriate use

The use of the positioning devices outside of the operating conditions and technical data and specifications described in the documentation is considered “improper”. The drives are designed for intended operation under normal ambient conditions (according to EN / IEC / UL 61010-1), with the exception of an extended temperature range.

- Operation inside buildings
- Operation at altitudes up to 2000m above sea level
- Ambient temperatures deviating from standard: 0°C to 45°C
- Maximum relative humidity 80% at temperatures up to 31°C, decreasing linearly to 50% relative humidity at 45°C
- Fluctuations in the supply voltage up to  $\pm 10\%$  of the nominal voltage at 50% relative humidity at 45°C
- The IP-protection rating is a manufacturer specification.

Any use of the device that goes beyond the intended use and/or is used differently can lead to dangerous situations

- Underwater usage of the PSW is not allowed
- The positioning system cannot be used for certain applications, such as the transport of people and animals or as a press-bending device for cold processing of metal.
- If the operation requirements stated in chapter 6. Technical Data are exceeded, personal injury or property damage may occur.
- The positioning system cannot be used in hazardous areas.
- The holding brake must not be used to brake the motor.
- Under no circumstances may the housing cover be used for power transmission purposes, e.g. for supporting, climbing or similar.



### **1.5 Limitation of liability**

The device may only be operated in accordance with these operating instructions. All information and instructions in these operating instructions have been compiled taking into account the applicable standards and regulations, the state of the art and our many years of experience and knowledge.

The manufacturer accepts no liability arising from improper or unintended use.

Warranty claims also expire in this case:

- non-observance of the operating instructions
- improper use
- improper installation
- improper use
- Use by untrained personnel
- Modifications to the device
- Technical modifications
- Unauthorized modifications

The user is responsible for carrying out commissioning in accordance with the safety regulations of the applicable standards and all other relevant national or local regulations regarding conductor dimensioning and protection, grounding, circuit breakers, overcurrent protection, etc. The person who carried out the assembly or installation is liable for any damage caused during assembly or connection.

### **1.6 Faults, maintenance, repair, disposal**

Faults or damage to the appliance must be reported immediately to the specialist personnel responsible for the electrical connection.









The appliance must be taken out of operation by the responsible specialist personnel until the fault has been rectified and secured against accidental use.

The appliance requires no maintenance.

Repair work that requires the housing to be opened may only be carried out by the manufacturer.

The electronic components of the appliance contain environmentally harmful substances and are also recyclable materials. The device must therefore be recycled after its final decommissioning. The environmental guidelines of the respective country must be observed.

## 1.7 Product labelling

Warning symbol	Meaning
	<p><b>Reference to further documentation</b> Read the operating instructions and safety instructions before transportation, installation or commissioning</p>
	<p><b>Warning of hot surface</b> The appliance can become very hot during operation. Temperatures of over 70°C can occur. In the event of a fault, internal components may be overloaded. Use personal protective equipment or wait long enough for the appliance to cool down.</p>
	<p><b>Warning of dangerous electrical voltage</b> Before working on the product, check that all power connections are de-energized!</p>
	<p><b>Disposal of batteries, electrical and electronic equipment</b></p> <ul style="list-style-type: none"> <li>• In accordance with international regulations, batteries, rechargeable batteries and electrical and electronic equipment must not be disposed of with household waste.</li> <li>• The owner is legally obliged to dispose of these devices properly at the end of their service life.</li> <li>• WEEE: This symbol on the product, its packaging or in this document indicates that a product is subject to these regulations.</li> </ul>
	<p><b>CE marking</b> CE stands for "Conformité Européenne". The CE marking expresses the conformity of a product with the relevant EC directives.</p>
	<p><b>UKCA marking</b> UKCA stands for "UK Conformity Assessed". The UKCA marking expresses the conformity of a product with all applicable legal requirements of the United Kingdom.</p>
	<p><b>Safe torque off</b> Corresponds to stop category 0 in accordance with EN 60204-1. The power supply to the drive is interrupted immediately and the drive is brought to an uncontrolled standstill</p>
	<p><b>GROUNDING</b> Chassis grounding (description in chapter 3.1 Electrical connection )</p>

## 2. Device description

### 2.1 Features

The PSx3xx positioning system, an intelligent, compact, complete solution for positioning auxiliary and positioning axes, consists of an EC motor, gear power amplifier, control electronics, absolute measuring system and PROFINET interface. The integrated absolute measuring system eliminates the need for a time-consuming reference run. Connecting to a bus system simplifies the wiring. A hollow shaft with adjustable collar makes assembly quite simple. The positioning system is especially suitable for automatically setting tools, stops or spindles for wood-processing equipment, packing lines, printing equipment, filling units and other types of special machines.

PSx3xx positioning systems convert a digital positioning signal into an angle of rotation.

### 3. Installation

#### 3.1 Electrical connection

##### NOTICE

The following notes on the power supply should be observed.

Minimum cross-sections are required for connection to the power supply. For power cables mounted on the device, use only the cross-sections listed below. In order to minimize voltage drop on longer cables, we always recommend using the largest available cross-section.

Device	Cable cross-section
PSEx31 / PSx32 / PSx33	min. AWG20 or 0,5 mm <sup>2</sup>
PSEx34	min. AWG18 or 1,0 mm <sup>2</sup>
Fieldbus connections	min. AWG23 or 0,25 mm <sup>2</sup>

If there are concerns about mechanical strength or where cables may be exposed to mechanical damage/stress, they must be protected accordingly. This can be ensured, for example, by a cable duct or a suitable armoured pipe.

If the power supply cables are laid in the immediate vicinity of the drives or other heat sources, make sure that the cables have a temperature resistance of at least 90°C. With suitable design measures, e.g. sufficient ventilation or cooling, lower temperatures are also permissible. This must be checked and determined by the customer.

Make sure that the flammability class of the cable for the USA is equivalent to UL 2556 VW-1, e.g. according to IEC 60332-1-2 or IEC 60332-2-2 depending on the cross-section. For Canada, the flammability class FT1 is required, FT4 exceeds this and is therefore also permissible. Cables for the North American market often meet both requirements.

However, the flammability class requirements only apply if you do not limit to Class 2 (e.g. certified power supply) or to <150 W according to UL 61010-1  
→3.6 Powering the device by means of a suitable fuse.

When installing in North America, please observe the specifications in the National Electrical Code NFPA 70 and the Electrical Standard for Industrial Machinery NFPA 79 (USA) or the Canadian Electrical Code and C22.2 (Canada) in the respective valid version.

Note the limitations of liability →1.5 Limitation of liability.

### 3.2 Assembly of the positioning system

#### CAUTION

The maximum permissible axial and radial forces (see chapter 6.3 Physical data) on the motor shaft must not be exceeded during transportation, installation or operation.

#### CAUTION

Take the weight of the device into account when selecting the fastening screws! Tightening torques of the fixing screws according to the screw manufacturer's specifications!

#### WARNING

Rotating and/or linearly moving components can cause serious injuries. If there is a risk of accidents during installation or operation, the moving parts must be fitted with guards or protective devices.

#### NOTICE

##### Temperature overload

The PSx3xx positioning unit has a simple temperature measuring device to prevent thermal overload. If the temperature in the device exceeds the limit temperature set in the parameterization, this bit is set and repositioning is only possible after the device has cooled down ('Temperature exceeded' bit reset).

#### 3.2.1 Hollow shaft

The PSx3xx is mounted on the machine by sliding it with the hollow shaft onto the spindle to be driven and fixing it with the clamping ring (recommended shaft diameter 8 h9 or 14 h9; tightening torque of the clamping ring screw with 3 mm hexagon socket: 1.5 Nm).

#### CAUTION

The depth of the hollow bore is 20 mm. For optimum operation, the pin of the shaft to be driven should correspond to this depth. Depending on the operating situation, significantly shorter pins (< 16 mm) may cause damage to the PSx3xx. When mounting the PSx3xx, it should only be pushed on until the foam rubber plate lies evenly on the bottom of the machine or is compressed to approx. half its thickness. Under no circumstances may the PSx3xx "hard" be screwed to the machine without an air gap.

The rotation lock is made via the pin (in the picture below the hollow shaft) into a suitable bore as rotary torque support. This hole must be slightly larger than the diameter 6 h9 of the pin. An oblong hole or slot with a slightly larger width (recommended: 6.05...6.10 mm) than the dimension of the pin diameter is optimal. The backlash when changing the direction of rotation has a direct influence on the positioning accuracy and can lead to damage to the PSx3xx with very large backlash (a few mm) due to the impact load.

**⚠ CAUTION**

The PSx3xx must have a little gap on all sides when mounted, as it can move axially and/or radially during positioning if the hollow shaft and solid shaft are not 100% aligned. This "staggering" is not a defect of the PSx3xx and also has no influence on the function, as long as it can move freely. Please note the maximum permissible radial force and axial force in chapter → 6.3 Physical data.

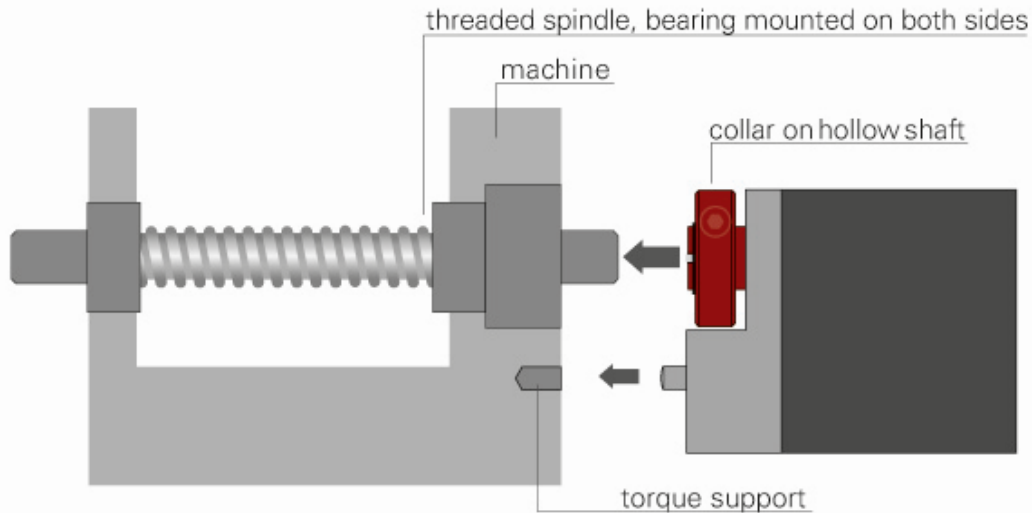

**Versions with higher torques (from 10 Nm):**

Here the force connection is made via a feather key DIN 6885-A5x5x12.

The clamping ring is not freely rotatable but consists of two halves, the fixed part of the hollow shaft and the loose clamping clamp. The keyway is located in the half that is fixed to the output shaft. When sliding onto the shaft to be driven with the key inserted, its angular position must be aligned with the keyway in the PSx3xxPN. After pushing on, the PSx3xx is fixed with the 2 screws in the flexible clamping ring half.

Make sure that both screws are tightened as equally as possible (tightening torque of the screws with 3 mm hexagon socket: 1.5 Nm).

The information on torque support applies in the same way as described above.

For PSE30x-14, PSE32x-14, PSS30x-14 and PSS32x-14, the position of the anti-rotation lock can be set at greater distances by unscrewing the base cover, turning it 180° and then screwing it back on. When screwing on, make sure that the seal is correctly inserted in the floor.

For torques > 5 Nm we recommend to choose the greater distance.

### 3.2.2 Solid shaft

The PSx3xx is installed on the machine by mounting the drive to the axis to be driven using a coupling and an intermediate flange.

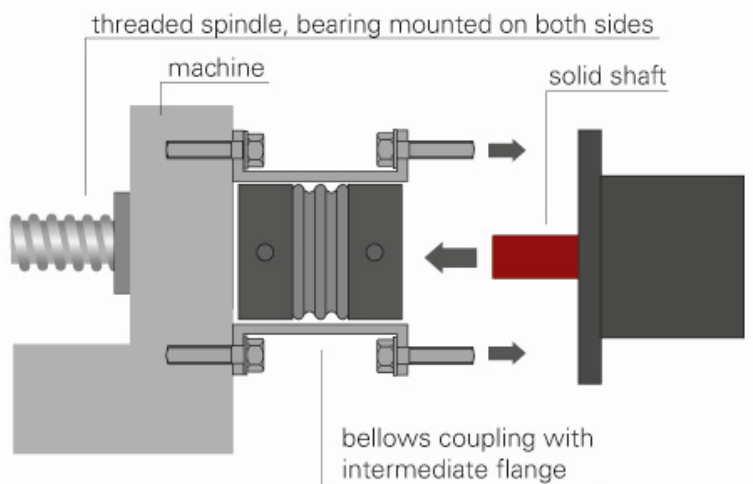

#### **⚠ CAUTION**

Under no circumstances may the housing cover be used for the purpose of the transmission of force.

#### **⚠ CAUTION**

Never apply force to the housing cover, e.g., for supporting weight

#### **⚠ CAUTION**

Driving the PSx3xx rearward is prohibited (e.g. it's not allowed to turn the output shaft by an external force).

### 3.3 Disassembly

To remove the PSx3xx from the shaft, release the clamp (for versions with hollow shaft the clamping ring) and pull the PSx3xx off the shaft. If possible, the PSx3xx should only be pulled axially. Excessive bending back and forth can damage the output shaft!

For versions with brake, it is essential to observe the instructions in sections 5.1 3 Devices with optional snap brake and 5.14 Devices with optional holding brake!

### 3.4 Powering the device

**⚠ CAUTION**

For motor power use a single fuse with max. 3,5 A for each PSx3xx.  
 For motor power use a single fuse with max. 10 A for each PSE34xx.  
 For control power you can use a fuse with max. 2,0 A, so it is possible to power up to 10 units parallel with one fuse.  
 It is strongly recommended to separate power cables to the PSx3xx from other power cables that might have dangerous voltage.

**⚠ CAUTION**

Underwater usage of the PSW is not allowed.

**⚠ CAUTION**

 Please consider that the device might have a hot surface during operation!

### 3.5 Pin assignment

**⚠ CAUTION**

Please take care that the mating connectors and the used cables match the connectors in the PSx3xx and are mounted correctly, in order to achieve the protection class.

#### 3.5.1 Supply voltage connector (24VDC)

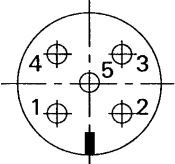
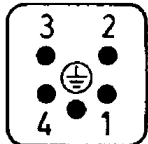
connector pattern (external top view)	assignment	type
	1. +24V motor 2. GND motor 3. +24V control unit 4. GND control unit 5. housing/pressure balance	PSE/PSS: M12 (A-cod.); 5-pol. PSW: M12 (A-cod.); 4-pol. with airtube
	1. +24V motor 2. GND motor 3. +24V control unit 4. GND control unit 5. housing/pressure balance	PSE34xx: HAN4A, Harting

**NOTICE**

To prevent the ingress of fluids into the PSW-housing during cooldown, use a special cable with an airtube for pressure balancing of your PSW.



**NOTICE**

In the special version with two M12 supply plugs, a maximum of 3 drives may be connected in series. Due to the maximum current load of the connectors, the drives must not be positioned synchronously.

**3.5.2 Round socket for bus (Port1 and Port2)**

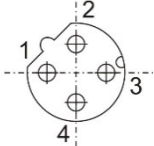
connector pattern (external top view)	assignment	type
	1. TD+ 2. RD+ 3. TD- 4. RD-	M12 (D-cod.); 4-pol.

**NOTICE**

Due to the use of 5-pin sockets, only five-wire cables should be used.

**3.5.3 One Hybrid bushing for supply and bus (Hybr)**

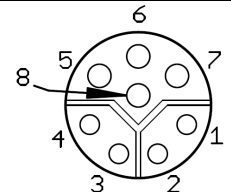
connector pattern (external top view)	assignment	type
	1. TD+ 2. TD- 3. RD+ 4. RD- 5. GND motor 6. GND control unit 7. +24V motor 8. +24V control unit	M12 (Y-cod.); 8-pol.

**3.5.4 Connector for jog keys (Jog)**

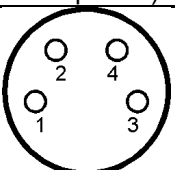
connector pattern (external top view)	assignment	type
	1. +24V output (=+24V control in supply voltage connector) 2. forward key 3. reverse key 4. ground (= GND control unit)	M8; 4-pol.

### 3.5.5 Connector-option -2Y-

Two Y-coded bushings for bus and control supply  
One A-coded connector for motor supply

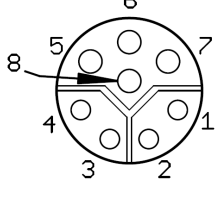
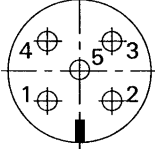
connector pattern (external top view)	assignment		type
	1. TD+ 2. TD- 3. RD+ 4. RD-	5. +24V control unit 6. GND control unit 7. +24V control unit 8. GND control unit	M12 (Y-cod.); 8-pol.
	1. +24V motor 2. 3. GND motor 4. 5.		M12 (A-cod.); 5-pol.

### 3.5.6 Electrical grounding (Chassis)

Next to the connecting plugs there is a M4 stud bolt. It is recommended to connect the positioning system with a cable as short as possible to the machine base. The minimum conductor cross-section for this is 1.5mm<sup>2</sup>.

### 3.6 Setting of the device name

It's possible to set the device name by 3 different ways:

- 1) For variants with address switches the device name is built up of a basic part and the address in the following way:

pse-xx

(xx is the setting of the address switches when powering on the drive, provided that the address is > 0)

- 2) If no address switches are included in the device or the setting of the address switches is "00", the address which is stored in the internal EEPROM is effective, in case it is > 0 (parameter 92). The device name then is built up in the following way:

pse-xxxxxx

- 3) If no address switches are included in the device or the setting of the address switches is "00" AND the address which is stored in the internal EEPROM is equal 0, the device name which was assigned at last by the IO controller is valid.

In delivery state address switches are at setting 0 (if present), the address which is stored in the internal EEPROM is 0 and the device name is empty (→ PROFINET compliant behaviour).

In order to identify the drive during start-up, the "blinking service" is supported, i.e. the drive can be accessed via the MAC address and a device naming can be executed.

### 3.7 LEDs

The following LEDs are located under the transparent sealing plug:

*P1/P2*: green LINK LEDs and yellow ACT LEDs for ports 1 and 2

*BF*: Profinet bus fault LED

*SF*: Profinet status fault LED

*V\_Motor*: The LED is illuminated yellow when power is available to the motor.

#### Switch configurations:

PSx30x, PSx31x-8,  
PSx32x, PSE34xx

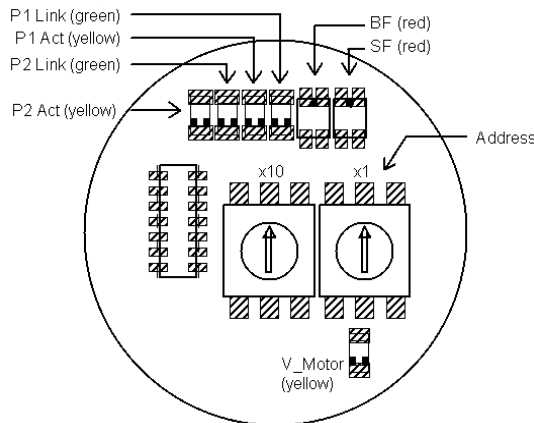

PSx31x-14, PSx33x-14,

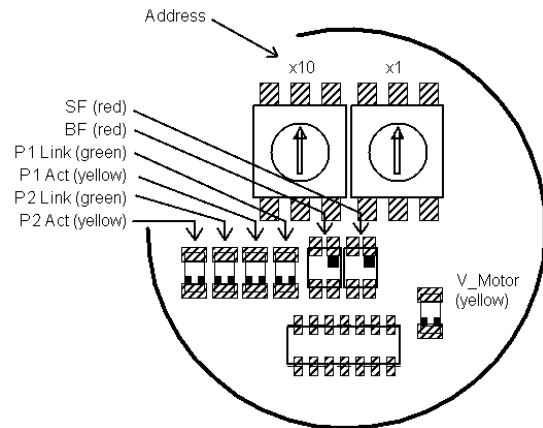

#### NOTICE

If the device names are given **without** the diameter of the output shaft (-8, -14), the relevant information is valid for **all** offered output shafts (applies throughout the document).

'x' in the device name stands for a number in the range 0..9. 'xx' in the device name stands for a number in the range 10..999.

#### NOTICE

Always replace the protective cap after setting the address. This will prevent dust and contaminants from entering the device.

#### Meaning of the LEDs:

1) Each of the ports (P1/P2) has two associated LEDs (one green for the "Link" state and one yellow for the "Activity" state).

For each port the following states are possible:

- green off, yellow off → no line connection
- green on, yellow off → line connection is active, no data activity
- green on, yellow is flickering with 10 Hz → line connection is active, data activity

2) red Profinet LED “bus fault” (BF)

- Off → The drive is in the process of exchanging data.
- Flashing with 2Hz → The drive is connected to the Ethernet network and is not in the process of exchanging data.
- On → The drive is not connected to the Ethernet network.

3) red Profinet LED “status fault” (SF)

- Off → No fault, no diagnostic message is present.
- Flashing with 2Hz, duration 3 sec. → DCP signal service is initiated via the bus
- On → Watchdog Time-out; system fault or diagnostic message is present

4) The yellow “motor” LED indicates the motor power supply:

- off → Motor power supply too low or too high
- on → Motor power supply well
- flashing → Motor power supply well, PSx in delivery state

### 3.8 Start-up

After the supply voltage has been hooked up, a positioning or manual run can begin immediately:

#### NOTICE

Runs which involve specifically a block run (e.g. reference runs on block), may only be started with reduced torque (max. torque max. 10% of the nominal torque).

### 3.8.1 Positioning run

- To be able to control the drive, first a cyclic process data connection has to be established.
- Transfer target value:  
control word = 0x14 and desired target value  
→ Drive begins run
- Abort run by resetting the release bit:  
control word = 0x00
- If a new target value is transferred during a positioning run, the device will immediately proceed to the new target. There will be no interruption if the direction of rotation does not need to be altered.
- If a manual run is transmitted during a positioning run, the positioning run will be aborted (speed will be reduced to that of a manual run) and the device proceeds with the manual run.

The following sequence of steps is also possible:

Starting situation: release has not been set

- Transfer target value:  
control word = 0x04 and desired target value
- Set release:  
control word = 0x10  
→ Drive begins run

#### NOTICE

Where applicable, positioning runs involve a “loop run” which causes the target position to be reached from a predefined direction. The direction and the length of the loop run can be set to the desired value with SDO #201F (“length of loop”) before the run. With SDO #201F, the loop run might also be disabled.

#### NOTICE

Setting of control word and target value with the help of SDOs is only possible in the CN cycle state “pre-operational”.

### 3.8.2 Manual run

- Start manual run (control word = 0x11 resp. 0x12): Drive begins run
- End manual run by clearing the manual run command (transmit control word = 0x10) or by deasserting release (transmit control word = 0x00).
- Transferring a target value during a manual run will end the manual run and the device will immediately move on to the transmitted position (control word = 0x14 and desired target value).

### 3.8.3 Restoring the factory settings (without controller)

It is also possible to set the drive to the delivery state without the presence of a controller. Carry out the following steps to do this:

- 1) Switch off the device.
- 2) Set the address switch to 98.
- 3) Switch on the device (control and motor voltage).
- 4) The yellow LED now flashes for 10s at 10Hz. If the address is set to 99 during this time, the drive sets all parameters to the delivery status, saves them and moves the axis to the middle position.
- 5) Set the address switch to 00 to complete the delivery status.
- 6) Switch off the device.

The 10-second period is terminated before it is complete when communication is established.

## 3.9 PROFINET interface

When setting up the project, care should be taken to use the appropriate DAP (either "PSx with 1 connector" or "PSx with 2 connectors"). When choosing the wrong DAP, no communication will establish.

### NOTICE

Although the mode "IRT" is mentioned in the GSD file associated to the device, currently only the mode "RT" is supported.

#### Process data:

As process data for the IO controller a 14-byte output module and a 16-byte input module exist. With the help of the process data, the positioning commands are initiated and monitored, besides parameters might be written and read. For that purpose, the "PKW parameter interface" is being used, which is described in the drive profile "Profidrive".

#### Acyclic read and write requests:

Access on all parameters is also possible with acyclic read and write requests instead via the PKW parameter interface. The parameter number is in both cases the same. When using acyclic write requests, it has to be considered that just before the effective value which a parameter shall receive, a control byte has to be transmitted, which specifies if the drive shall execute or ignore the write request. If the write request shall be ignored, this control byte has to be set to 0, otherwise the write request will be executed.

**NOTICE**

Thus, the data length of the write requests result to 3 byte for 16-bit values and 5 byte for 32-bit values.

**NOTICE**

For acyclic reading, the data length of the returned value is 2 byte for 16-bit values and 4 byte for 32-bit values.

The advantage of this method is when doing a parametrization in the context of running up a device, a parameter might be taken over out of the project design or alternatively the values which are stored in the EEPROM of the drive keep their validity. This is being controlled by the control byte which was described before and which is present for each parameter in the GSD file and which is being displayed in the project design.

### 3.9.1 Table of implemented parameter entries

Name	Par. Number	Function	Type/Range	Back up	Delivery State	R/W
<b>Status requests</b>						
status word	1	<u>Bit 0:</u> target position reached <u>Bit 1:</u> drag error <u>Bit 2:</u> reverse jog key active <u>Bit 3:</u> forward jog key active <u>Bit 4:</u> motor power present <u>Bit 5:</u> positioning run aborted <u>Bit 6:</u> drive is running <u>Bit 7:</u> temperature exceeded <u>Bit 8:</u> movement opposite loop direction <u>Bit 9:</u> error <u>Bit 10:</u> positioning error (block) <u>Bit 11:</u> manual displacement <u>Bit 12:</u> incorrect target value <u>Bit 13:</u> motor power was missing <u>Bit 14:</u> positive range limit <u>Bit 15:</u> negative range limit	0 ... 0xFFFF 16 bit			R
actual speed	2	value in 1/min	±15 bit			R
actual value	3	current actual position value in 1/100 mm (for a 4mm spindle and default settings of numerator, Par. 38 and denominator, Par. 39) Writing onto this parameter causes the current position to be “referenced” onto the transferred value. Changes only possible when at standstill	±31 bit	no		R/W
actual torque	4	value in cNm	16 bit			R
maximum torque	5	maximum torque occurring during the most recent run (start phase, during which the maximum start-up torque applies, see Par. 63/71, and the phase when the drive is braking down, are not considered) value in cNm	16 bit			R
U control	6	current supply voltage for control unit given in increments of 0.1 V	16 bit			R
U motor	7	current supply voltage for motor given in increments of 0.1 V	16 bit			R
device temperature	8	internal device temperature in °C	16 bit			R
address switch	9	current setting of the (optionally present) address switch	16 bit			R
production date	10	year and week of manufacturing (given as an integer)	YYWW 16 bit			R
serial number	11	serial device number	0 ... 65535 16 bit			R



Name	Par. Number	Function	Type/Range	Back up	Delivery State	R/W
<b>Status requests (continued)</b>						
device model (as number)	12	device model within the PSE series as number (e.g. 31208)	16 bit			R
device model (as string)	13	device model within the PSE series as string (e.g. "PSE312-8-B") When requesting with "Read Record", the drive is sending the string as one piece, when requesting via the PKW parameter interface, consecutively 5 segments have to be requested (IND = 0...4), with each of them containing 4 byte (example for the first read double word: 0x50534533). The string is zero-terminated.				R
version	14	software version number	16 bit			R
<b>Run commands</b>						
control word (only writable in process data)	32	<u>Bit 0</u> : manual run to larger values <u>Bit 1</u> : manual run to smaller values <u>Bit 2</u> : transfer target value <u>Bit 3</u> : Enable manual operation in jog mode <u>Bit 4</u> : release: The axle will only run if this bit is set <u>Bit 5</u> : Enable jog mode with keys: When the bus connection is active, the external keys are only active when the bit is set. <u>Bit 6</u> : Run without loop <u>Bit 7</u> : Execute switch-on loop movement <u>Bit 8</u> : Jog to larger values <u>Bit 9</u> : Jog to smaller values <u>Bit 14</u> : Error Acknowledge (available from firmware V3.02) All other bits must be set to 0!	16 bit	no	0	R
target value (only writable in process data)	33	target position to be achieved value in 1/100 mm (for a 4mm spindle and default settings of numerator, Par. 38 and denominator, Par. 39)	±31 bit	no	0	R

Name	Par. Number	Function	Type/Range	Back up	Delivery State	R/W
Parameter group "position settings"						
direction of rotation	37	0: clockwise with larger values (if looking at the output shaft) 1: counter clockwise with larger values Changes only possible when at standstill	0 or 1 16 bit	yes	0	R/W
position scaling, numerator	38	These values can be used to set a desired user resolution to the drive. For a numerator factor of 400, the denominator factor holds the spindle pitch per resolution e.g.: spindle pitch 1.5 mm with resolution 1/100 mm: numerator = 400, denominator = 150 Changes only possible when at standstill	1...10000 16 bit	yes	400	R/W
position scaling, denominator	39		1...10000 16 bit	yes	400	R/W
referencing value	40	correction factor for the target, actual and limit switch values Changes only possible when at standstill	±31 bit	yes	0	R/W
upper mapping end	41	definition of the positioning range relative to the absolute measuring system permissible values: (actual position value + 3 revolutions) ... (actual position value + 253 revolutions) Changes only possible when at standstill	±31 bit	yes	102400	R/W
upper limit	42	maximum permitted target position minimum value: upper mapping end - 253 revolutions maximum value: upper mapping end - 3 revolutions Changes only possible when at standstill	±31 bit	yes	101200	R/W
lower limit	43	minimum permitted target position minimum value: upper mapping end - 253 revolutions maximum value: upper mapping end - 3 revolutions Changes only possible when at standstill	±31 bit	yes	1200	R/W
positioning window	44	permissible difference between target and actual values for "position reached" bit value in 1/100 mm (for a 4mm spindle and default settings of numerator and denominator) The maximum value that can be set changes according to the same factor as the resolution. Changes only possible when at standstill	1...100 16 bit	yes	2	R/W
length of loop	45	minimum number of increments which the drive moves in a pre-defined direction when approaching a target position value in increments (value = 0 → no loop) Changes only possible when at standstill	-1...1 rotation ±31 bit	yes	-250	R/W

Name	Par. Number	Function	Type/Range	Back up	Delivery State	R/W
Parameter group "position settings" (continued)						
drag error	46	maximum drag error before the "drag error" bit is set. value in 1/100 mm (for a 4mm spindle and default settings of numerator and denominator)	0...1000 16 bit	yes	0	R/W
readjustment	47	readjustment at standstill 0 → off; 1 → on	0 or 1 16 bit	yes	0	R/W
drag error correction	48	maximum modification of the target speed for drag error correction Changes only possible when at standstill	0...10 16 bit	yes	4	R/W
size of individual increment	49	number of increments when external keys pressed (or when activating a jog run bit) for a short-time The maximum value that can be set changes according to the same factor as the resolution. Writing is only possible at standstill.	1...100 16 bit	yes	1	R/W
Parameter group "velocity"						
target speed	53	maximum rpm to be used for positioning runs; value in 1/min	*) 16 bit	yes	*)	R/W
target speed for manual run	56	maximum rpm to be used for manual runs value in 1/min	*) 16 bit	yes	*)	R/W
speed limit for aborting run	57	value in % of the target speed	30...90 16 bit	yes	30	R/W
acceleration	58	value in 1/min per sec.	*) 16 bit	yes	*)	R/W
deceleration	59	value in 1/min per sec.	*) 16 bit	yes	*)	R/W
Parameter group "torque"						
maximum start-up torque **)	63	value in cNm	*) 16 bit	yes	*)	R/W
maximum torque **)	64	Applies after completion of start phase (during start phase the value Par. 63 applies); value in cNm	*) 16 bit	yes	*)	R/W

\*) Values depend on device type (see following table).

\*\*) The power is controlled in such a way that the resulting torque never exceeds the value specified in par. 63 or par. 64, even if the drive cannot reach the set speed (e.g. due to stiffness).

Name	Par. Number	Function	Type/Range	Back up	Delivery State	R/W
maximum holding torque at end of run	65	value in cNm	*) 16 bit	yes	*)	R/W
maximum holding torque	66	maximum holding torque at standstill in cNm (after completion of the phase "max. holding torque at end of run")	*) 16 bit	yes	*)	R/W
<b>Parameter group "time"</b>						
time elapsed until speed falls below speed limit for aborting run	70	value in msec (see also Par. 57)	50...500 16 bit	yes	200	R/W
time period for start-up torque	71	time period at begin of run, in which the "maximum start-up torque" applies (value in msec, see also Par. 63)	10...1000 16 bit	yes	200	R/W
duration of maximum holding torque at end of run	72	time period at end of run, in which the "maximum holding torque at end of run" applies (value in msec, see also Par. 65)	0...1000 16 bit	yes	200	R/W
idle period for direction change	73	idle period when reversing the direction of rotation (value in msec)	10 ... 10000 16 bit	yes	10	R/W
idle period for manual run	74	Span of time a manual run key must be pressed (or a jog run bit must be activated) in order to begin a manual run Changes only possible when at standstill. (value in steps of 5 msec)	100... 10000 16 bit	yes	1000	R/W
waiting time for brake at end of run	75	time period after the end of run, in which the brake stays released (value in msec)	0...3000 16 bit	yes	1000	R/W
UMot filter	76	average time for measuring current power to motor (value in msec)	100 ... 1000 16 bit	yes	100	R/W
<b>Parameter group "others"</b>						
general purpose	80-89	10 general purpose registers	32 bit	yes	0	R/W
Umot limit	90	voltage limit for bit 4 ("motor power present"); given in increments of 0.1 V  Beginning a positioning run or a manual run is only possible if the supply voltage for the motor is higher than the value of this parameter. During the run the voltage might fall down to 17.5V.	180 ... 240 16 bit	yes	185	R/W
temperature limit	91	upper temperature limit in °C	10...70 16 bit	yes	70	R/W

Name	Par. Number	Function	Type/Range	Back up	Delivery State	R/W
Parameter group "others" (continued)						
address	92	<p>If no address switches are included in the device or the setting of the address switches is "00", this value is effective as address, in case it is &gt; 0. The device name then is built up in the following way:</p> <p>pse-xxxxx</p> <p>When writing, this value only will be valid after saving (s. Par. 96) and restart.</p> <p>If additionally to the address switch setting "00" parameter 92 is zero, the name which was assigned by the IO controller during device naming is valid.</p>	16 bit	yes	0	R/W
configuration for connection timeout	93	<p><u>Bits 1-0</u>: configuration for connection timeout (if a connection has been established and lost)</p> <p>0x00: continue moving (drive will continue moving to the actual target position)</p> <p>0x01: drive will abort any positioning</p> <p>0x02: drive will move to the safe position which is defined by Par. 94</p> <p>0x03: reserved</p> <p><u>Bits 3-2</u>: configuration of safe position run when no connection is being established after a certain time at power-up</p> <p>0x00: no safe position run at power-up</p> <p>0x01: safe position run after 15 sec</p> <p>0x02: safe position run after 30 sec</p> <p>0x03: safe position run after 60 sec</p> <p><u>Bits 5-4</u>: response of the drive if "IOPS = BAD" (e.g. by CPU Stop)</p> <p>0x00: continue moving (drive will continue moving to the actual target position)</p> <p>0x01: drive will abort any positioning</p> <p>0x02: drive will move to a safe position which is defined by Par. 94</p> <p>0x03: reserved</p>	16 bit	yes	1	R/W
safe position for connection timeout	94	<p>drive will move to this position if</p> <ul style="list-style-type: none"> <li>- a connection loss has been detected and bits 1-0 of Par. 93 are set to 0x02</li> <li>- the state „IOPS = BAD“ has been detected (e.g. by a CPU stop) and bits 5-4 of Par. 93 are set to 0x02</li> <li>- no connection is being established after a certain time at power-up and bits 3-2 are being set appropriate</li> </ul>	±31 bit	yes	0	R/W

Name	Par. Number	Function	Type/Range	Back up	Delivery State	R/W
Parameter group "others" (continued)						
repetition time for safe position run	95	drive will start another safe position run if the last safe position run was not successful (e.g. because of undervoltage, positioning error (block) or overtemperature) value in sec; 0 → no repetition	16 bit	yes	0	R/W
delivery state	96	<p><u>writing "-6"</u>: resets the drive (equal to switching off and on again the control power supply)</p> <p><u>writing "-5"</u>: sets the values of all parameters to the delivery state, saves all parameters in the EEPROM, afterwards positioning run to the middle of the measurement range *) (device name and IP address stay unaffected)</p> <p><u>writing "-4"</u>: sets the values of all parameters to the values which are saved last by the user, afterwards positioning run to the middle of the selected positioning range *) (device name and IP address stay unaffected)</p> <p><u>writing "-3"</u>: sets the values of all parameters to the delivery state, erases the device name and the IP address and saves all parameters in the EEPROM</p> <p><u>writing "-2"</u>: sets the values of all parameters to the values which are saved last by the user, without saving the parameters in the EEPROM (device name and IP address stay unaffected)</p> <p><u>writing "-1"</u>: sets the values of all parameters to the delivery state, without saving the parameters in the EEPROM (device name and IP address stay unaffected)</p>	-6...-1 or 1 (writing) 0...2 (reading) ±15 bit	no		R/W

\*) In cyclic process data exchange, the control word is ignored during a run to the middle of the measurement range (unless it changes). Thus a run to the middle of the measurement range may be interrupted by a change of the control word. Run commands issued before the run to the middle of the measurement range will not automatically restart after finishing the the run to the middle of the measurement range. (I. e. control word 0x14 and old target position will not lead to a run to this position.)

Name	Par. Number	Function	Type/Range	Back up	Delivery State	R/W
Parameter group "others" (continued)						
delivery state	96	<u>writing "1":</u> saves all parameters in the EEPROM <u>reading directly after boot:</u> 0 → content of memory correct ≠ 0 → content of memory incorrect <u>reading after saving:</u> 0 → saving finished successfully ≠ 0 → saving is still in progress or is finished incorrectly (the time for saving is up to 200 msec) Changes only possible when at standstill	-6...-1 or 1 (writing) 0...2 (reading) ±15 bit	no		R/W

### 3.9.2 Table of rated speed and torque values for various models of gears

device model PSE		328-14	3110-14	3125-14	3325-14	3410-14	3418-14
Name	Par.-No.	value range delivery state					
target speed	53	5...45 45	1...30 30	1...12 12	2...18 15	10...100 100	10...90 90
target speed for manual run	56	5...45 22	1...30 12	1...12 5	2...18 6	10...100 40	10...90 30
acceleration	58	22...100 100	9...50 50	4...20 20	8...45 45	20...350 350	10...315 315
deceleration	59	22...100 100	9...50 50	4...20 20	8...45 45	20...350 350	10...315 315
maximum start-up torque	63	80...960 960	100...1200 1200	250...3000 3000	250...3000 3000	100...1200 1200	500...2000 2000
maximum torque	64	80...960 800	100...1200 1000	250...3000 2500	250...3000 2500	100...1200 1000	500...2000 1800
maximum holding torque at end of run	65	0...700 300	0...1200 400	0...2500 900	0...2500 900	0...600 400	0...900 600
maximum holding torque	66	0...450 150	0...600 200	0...1250 450	0...1250 450	0...300 200	0...450 300

device model PSE and PSS		301-x 311-x	302-x 312-x	305-x 315-8	322-14 332-14	325-14 335-14
Name	Par. No.	value range delivery state				
target speed	53	15...230 230	10...150 150	3...70 70	20...200 170	10...100 85
target speed for manual run	56	15...230 80	10...150 50	3...70 20	20...200 80	10...100 40
acceleration	58	97...600 600	50...400 400	23...130 130	97...525 525	50...260 260
deceleration	59	97...600 600	50...400 400	23...130 130	97...525 525	50...260 260
maximum start-up torque	63	2...125 125	10...250 250	50...600 600	10...250 250	20...500 500
maximum torque	64	2...125 100	10...250 200	50...600 500	10...250 200	20...500 400
maximum holding torque at end of run	65	0...180 60	0...300 100	0...600 200	0...200 70	0...400 140
maximum holding torque	66	0...90 30	0...150 50	0...300 100	0...100 35	0...200 70

device model PSE and PSS		338-14	3210-14 3310-14	3218-14
Name	Par.- No.	value range delivery state		
target speed	53	8...85 55	5...45 38	3...30 28
target speed for manual run	56	8...85 15	5...45 15	3...30 10
acceleration	58	37...200 200	20...117 117	11...70 70
deceleration	59	37...200 200	20...117 117	11...70 70
maximum start-up torque	63	80...840 840	100...1200 1200	180...2200 2200
maximum torque	64	80...840 700	100...1200 1000	180...2200 1800
maximum holding torque at end of run	65	0...700 240	0...1000 350	0...1800 600
maximum holding torque	66	0...350 120	0...500 175	0...900 300



device model PSW		301-x 311-x	302-x 312-x	305-x 315-8	322-14 332-14	325-14 335-14
Name	Par. No.	value range delivery state				
target speed	53	15...180 180	10...125 125	3...60 60	20...150 125	10...80 60
target speed for manual run	56	15...180 80	10...125 50	3...60 20	20...150 80	10...80 40
acceleration	58	97...600 600	50...400 400	23...130 130	97...525 525	50...260 260
deceleration	59	97...600 600	50...400 400	23...130 130	97...525 525	50...260 260
maximum start-up torque	63	2...125 125	10...250 250	50...600 600	10...250 250	20...500 500
maximum torque	64	2...125 100	10...250 200	50...600 500	10...250 200	20...500 400
maximum holding torque at end of run	65	0...180 60	0...300 100	0...600 200	0...200 70	0...400 140
maximum holding torque	66	0...90 30	0...150 50	0...300 100	0...100 35	0...200 70

device model PSW		328-14	338-14	3210-14 3310-14	3218-14	3318-14
Name	Par.- No.	value range delivery state				
target speed	53	5...35 35	8...80 50	5...45 38	3...24 20	2...18 15
target speed for manual run	56	5...35 22	8...70 20	5...45 15	3...24 10	2...18 6
acceleration	58	22...100 100	50...260 260	20...117 117	11...70 70	8...45 45
deceleration	59	22...100 100	50...260 260	20...117 117	11...70 70	8...45 45
maximum start-up torque	63	80...960 960	100...800 800	100...1200 1200	180...2200 2200	250...2000 2000
maximum torque	64	80...960 800	100...800 700	100...1200 1000	180...2200 1800	250...2000 1800
maximum holding torque at end of run	65	0...700 300	0...700 240	0...1000 350	0...1800 600	0...2500 900
maximum holding torque	66	0...450 150	0...350 120	0...500 175	0...900 300	0...1250 450

### 3.9.3 Structure of process data

1) Output module (from the perspective of the IO controller)  
Assignment (cannot be modified):

Byte	Description	corresponding parameter number
0-1	PKE	
2-3	IND	
4-7	PWE	
8-9	control word	32
10-13	target position	33

2) Input module (from the perspective of the IO controller)  
Assignment (cannot be modified):

Byte	Description	corresponding parameter number
0-1	PKE	
2-3	IND	
4-7	PWE	
8-9	status word	1
10-11	actual speed	2
12-15	actual position	3

#### NOTICE

In the GSD file for the PSx3xxPN the two parameters "control word" and "status word" are oriented bit-wise (e.g. the flag "UseAsBits" is set respectively). This allows engineering tools to list the individual bits of these parameters separately. Due to this feature, the byte order of these parameters is inverted compared to the other parameters. If these parameters are being read or written as a whole, this circumstance has to be noted.

### 3.9.4 Detailed description of the status bits

*Bit 0:* target position reached

This bit is set:

- when a transferred target position has been reached successfully (not at the end of a manual run, otherwise the target position is the same as the applicable limit switch)
- after manual displacement while at standstill, if readjustment is activated and the absolute value of the difference of actual and target value is smaller or equal to the positioning window again

**If bit 0 should be set simultaneously with bit 10 (Block), bit 0 has priority!**

This bit is reset:

- after transferring a target position if the difference from the actual value is larger than the positioning window (Par. 44)
- by a manual run
- if an invalid target value has been transferred
- if rotated manually when on standstill

- Bit 1:* drag error  
This bit is set:  
- if during a run (except in the braking phase) the difference between actual target position and actual position exceeds the value which has been set with Par. 46  
This bit is reset:  
- with each new run command  
- with a 0 → 1 edge of the bit "Error Acknowledge" (available from FW V3.02)
- Bit 2:* reverse jog key active  
This bit is set:  
- if Pin 3 on the key connector is connected with Pin 1 (+24V)  
This bit is reset:  
- if Pin 3 on the key connector is disconnected from Pin 1 (+24V)
- Bit 3:* forward jog key active  
This bit is set:  
- if Pin 2 on the key connector is connected with Pin 1 (+24V)  
This bit is reset:  
- if Pin 2 on the key connector is disconnected from Pin 1 (+24V)
- Bit 4:* motor power present  
This bit is set:  
- if the supply voltage to the motor is above the  $U_{mot}$  limit (Par. 90) and below 30V  
This bit is reset:  
- if the supply voltage to the motor is below the  $U_{mot}$  limit or above 30V
- Bit 5:* positioning run aborted  
This bit is set:  
- if a positioning run is aborted because release in the control word has been withdrawn or because of an invalid bit combination in the control word  
This bit is reset:  
- with each new run command  
- with a 0 → 1 edge of the bit "Error Acknowledge" (available from FW V3.02)
- Bit 6:* drive is running  
This bit is set:  
- when the drive is rotating  
This bit is reset:  
- when the drive is on standstill
- Bit 7:* temperature exceeded  
This bit is set:  
- if the internal device temperature exceeds the limit value (Par. 91)  
This bit is reset:  
- if the internal device temperature falls below the limit value by 5°C

- Bit 8:** movement opposite loop direction  
This bit is set:
- after power-up or a reset (a lash in a driven spindle which might be present is not yet eliminated)
  - when commanding a positioning run or a manual run in opposite of the loop direction
  - when commanding a positioning run or a manual run, when no loop is configured (Par. 45 is zero)
- This bit is reset:
- when a transferred target position has been reached successfully in the loop direction (not after a manual run)
- Bit 9:** error  
This bit is set:
- if an internal problem is detected when calculating a position  
No run commands can be executed when the error bit is set!
- This bit is reset:
- only possible by resetting or power-cycle the drive
- Bit 10:** positioning error (block)  
This bit is set:
- if a positioning run or a manual run is aborted because the device is overloaded (block, extreme difficulty while running)
- If bit 0 (target position reached) is set simultaneously with bit 10, bit 0 has priority.!**
- This bit is reset:
- with each new run command
  - with a 0 → 1 edge of the bit "Error Acknowledge" (available from FW V3.02)
- Bit 11:** manual displacement  
This bit is set:
- if, while on standstill, the drive is turned externally by more than the value in the positioning window after a positioning run has been finished correctly
- This bit is reset:
- with each new run command
  - with a 0 → 1 edge of the bit "Error Acknowledge" (available from FW V3.02)
- Bit 12:** incorrect target value  
This bit is set:
- when a transferred target value lies outside of the limit switches; also caused, for instance, because of the actual value of the referencing value (Par. 40)
  - when a transferred target value lies inside of the limit switches; but because of a necessary loop run the specified interval would be left
- This bit is reset:
- with each new run command
  - with a 0 → 1 edge of the bit "Error Acknowledge" (available from FW V3.02)

*Bit 13:* motor power was missing

This bit is set:

- if the power to the motor is less than the Umot limit (Par. 90) or above 30V when initiating a positioning run or a manual run
- if during the run the voltage leaves the given corridor

This bit is reset:

- if the power to the motor is above the Umot limit and below 30V when initiating a positioning run or a manual run
- with a 0 → 1 edge of the bit "Error Acknowledge" (available from FW V3.02)

*Bit 14 / 15:* positive / negative range limit

This bit is set:

- if the limit value is reached during a manual run (but not if reached during a positioning run)
- if a limit value is modified such that the current position lies beyond the limit
- if, while on standstill, by means of an external force the drive is moved to a position which is outside the area which is defined by the range limits

This bit is reset:

- as soon as the actual position is again inside the range limits (Exception: After the end of a manual run the drive is located still at the range limit within the positioning window and no new run command was issued yet.)

### 3.9.5 Detailed description of control bits

*Bit 0:* manual run to larger values

*Bit 1:* manual run to smaller values

*Bit 2:* transfer target value

The target value in the process data is being accepted as a new valid target value, if this bit is set. A positioning run which starts simultaneously or later uses this target value as new target position. If together with taking over the target value the positioning run shall start immediately, bit 4 ("release") has to be set additionally.

If bit 2 is not set, the target value will not be taken over, instead there might be a positioning run to the target value which has been sent at last and which has been marked as valid.

*Bit 3:* Enable manual movement in jog mode:

In jog mode (movement by keys if bit 5 is set; or with bit 8 or 9 set in the control word if bits 4 and 5 are not set), manual movement is only activated if bit is set, when the key is pressed for a long time (or a jog movement bit is activated for a long time). If the bit is cleared, only single steps are possible in jog mode.

*Bit 4:* Release

Run commands will only be executed if this bit is set.

This bit must be set for positioning runs and manual runs.

If this bit is cleared during a run, the run will be aborted and status bit 5 will be set ("positioning run aborted").

- Bit 5:** Enable jog mode with keys  
If the bus connection is active, jog mode via keys is only possible if this bit is set and bit 4 is not set. For jog operation via bus (bits 8 or 9 in the control word), this bit must not be set.
- Bit 6:** Driving without a loop  
If this bit is set, all destinations are approached directly during positioning movements (regardless of the current value of par. 45) without any loop.
- Bit 7:** Execute switch-on loop  
5/8 turns against loop direction and then 5/8 in loop direction with manual speed (for default value of loop length par. 45). The control word is ignored during a switch-on loop movement until it changes. Thus a switch-on loop can be aborted with control word = 0.
- Bit 8:** Jog to larger values: Corresponds functionally to a pressed key forward (bit 3 in status). Bits 4 must be set in this operating mode!
- Bit 9:** Jog to smaller values: Functionally corresponds to a pressed key backwards (bit 2 in status). Bits 4 must be set in this operating mode!
- Bits 10-13:** reserved, must be programmed to 0
- Bit 14:** Error Acknowledge  
With a 0 → 1 edge of this bit, the error bits 1, 5, 10, 11, 12 and 13 in the statusword are deleted (available from FW V3.02)
- Bit 15:** reserved, must be programmed to 0

### 3.9.6 PKW parameter interface

Via the PKW parameter interface it's possible to write and read parameter values by using the cyclic process data connection, besides, also other values might be retrieved from the drive.

With the help of the PKW parameter interface the IO controller sets and transmits a new command. It repeats this command cyclically until the drive has processed the command and has sent back an answer. The drive provides this answer until the IO controller formulates a new command. A parameter value that's being sent back by the the drive as an answer to a read request, refers to the moment at which the IO controller has been issued the command. I.e. in case of a parameter value that should be monitored for a longer time, the IO controller has to send another command after taken over the actual parameter value. This takes place by setting the request identifier 0 ("no request") and subsequent waiting, until the drive confirms this request with the response identifier 0 ("no response"). Afterwards the same parameter value might be requested again.

One drive can only process one request at a time.

Structure of the PKW parameter interface:

PKW							
PKE		IND		PWE			
0	1	2	3	4	5	6	7

PKE = Parameter identifier

IND = Index

PWE = Parameter value

Structure of the parameter identifier PKE:

The information “parameter identifier” (PKE) consists of a data word (byte 0 and 1 of the PKW parameter interface), in which the type of the request (or the response) and the related parameter number are coded:

Parameter identifier PKE															
Bit No.															
15	14	13	12	11	10	9	8	7	6	5	4	3	2	1	0
AK				SPM		Parameter number (PNU)									

AK = request identifier or response identifier

SPM → not used, set to 0

PNU = Parameter number

The parameter number (PNU) refers to the table above (“Table of implemented parameter entries”).

Request identifier (IO controller → drive):

Request identifier	Function	Possible response identifier of drive *)	
		positive	negative
0	No request	0	7
1	Request parameter value	1 or 2	
2	Modify parameter value (word)	1	
3	Modify parameter value (double word)	2	
6	Request parameter value (array)	4 or 5	
7	Modify parameter value (array, word)	4	
8	Modify parameter value (array, double word)	5	
9	Request number of array elements	6	

)\* The column “response identifier” contains the possible responses for a certain request, distinguished between a successful completion of the request (“positive”) or an error (“negative”).

Response identifier (drive → IO controller):

Response identifier	Function
0	No response
1	Transfer parameter value (word)
2	Transfer parameter value (double word)
4	Transfer parameter value (array, word)
5	Transfer parameter value (array, double word)
6	Transfer number of array elements
7	Cannot process request (with error number)

Subindex IND:

For requests and responses which refer to array elements, the field IND contains the array subindex.

Parameter value PWE:

This field contains the numerical value which belongs to the related parameter.

When a request cannot be completed successfully (e.g. response identifier AK = 7), the drive reports an error code according to the following table:

Error code	Meaning
0	Illegal parameter number
1	Parameter value cannot be modified
2	Minimum/maximum limit exceeded
3	Faulty subindex
4	No array
5	Incorrect data type
6	Setting not allowed (resetting only)
17	Request cannot be processed due to operating state
18	Other error

When a write request is being completed successfully (e.g. request identifier AK = 2, 3, 7 or 8) the response contains the same data as a read request of this parameter. The response identifier then is one of the values 1, 2, 4 or 5, depending on the data type. The parameter number PNU, the index IND and the parameter value PWE are the same as given in the request. Hence it is possible to check again that the drive actually took over the requested values.



## 4. Sequence of positioning

### 4.1 Positioning run (with loop)

By default, the PSx3xx always approaches each setpoint from the same direction. If a destination is in the opposite direction to the loop direction, the setpoint is first traversed by the value of the loop length (Par. 45) and then finally approached. This can, for example, eliminate the backlash of a driven spindle.

The PSx3xx thus distinguishes the following cases during a positioning process:  
Assumption: Each target position is approached in forward direction, i.e. the loop length is  $-250 = 5/8$  revolutions.

1. New setpoint position is greater than the current actual position: The target is approached directly.



2. New setpoint position is smaller than the current actual position: The device is moved further back by the loop length (2a) and the final destination is then approached in forward motion (2b).

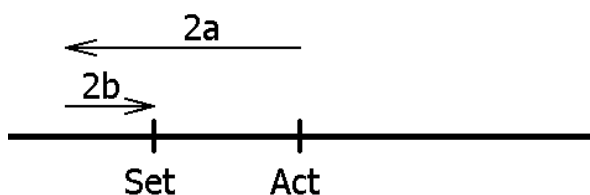

3. New setpoint position is only slightly larger than the current actual position and previously there was no positioning movement with loop (e.g. a manual movement):

In all cases, the drive approaches the target with a forward movement whose length corresponds at least to the loop length. In order to achieve this, the drive first moves in reverse direction (3a), i.e. against the actually desired direction of travel, and then forwards the actual destination (3b).

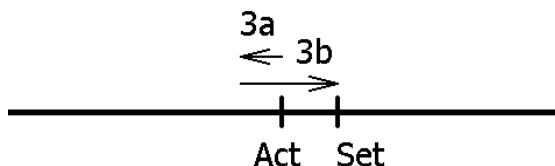

The maximum length of this distance is the loop length. If the setpoint differs from the current actual value by more than the loop length, it is approached directly.

After reaching the target position, this position is compared with the internal absolute encoder status. If there is a deviation, the status bit "Error" is set (bit 9 in the status word).

In the delivery state, the loop length is  $-250$  steps, i.e. each setpoint position is approached in the forward direction.

**NOTICE**

A positioning to the upper end limit (Par. 42) with a loop length  $> 0$  is not possible, since the drive would have to cross the end limit for this. The same applies to the lower end limit (Par. 43) with a loop length  $< 0$ .

**4.2 Sequence of a positioning process without a loop**

The "Positioning without looping" mode is mainly used for moving small distances for fine corrections. Each position is approached directly. Any backlash in the driven spindle is NOT eliminated. The internal gear backlash of the PSx3xx does not occur in this case either, since the position measurement takes place directly on the output shaft.

## 5. Specials

### 5.1 Speed, acceleration and deceleration

Manual runs are performed at the maximum speed specified in Par. 56; positioning runs are performed at the maximum speed specified in Par. 53. For all runs the maximum acceleration in Par. 58 and the maximum deceleration in Par. 59 apply. At the end of each run the maximum deceleration decreases during the approach to the destination successively in order to realize a harmonic transient behaviour.

A stop command causes the drive to brake with the maximum deceleration, independently of the setting in Par. 59.

### 5.2 Maximum starting torque and maximum torque

Via Par. 63 the maximum starting torque can be set, via Par. 64 the maximum driving torque.

The starting torque is active for the period in Par. 71 after each start of travel. It should always be slightly higher than the driving torque, since the drive requires more torque for the acceleration phase than for constant driving.

Both values are not sharp torque limits, instead the motor current is limited to a value which corresponds to the current consumption at the nominal speed at the set torque. If a lower speed than the rated speed is set, the achievable torque is slightly higher than at the (default) nominal speed.

#### NOTICE

If small torque limits are to be used, it must be considered not to use these in combination with high speed values, as this can lead to unstable driving behaviour!

### 5.3 Response of drive in case of block

If during a run due to load the speed falls below the threshold parameter of 30% of the selected maximum speed (Par. 57) for longer than 200 msec (Par. 70), the device detects blocking, aborts the run and sets the "positioning error" bit (here the default values are given). The drive from now on stands with the selected holding torque (Par. 66).

New run commands can then be transmitted with no further steps to take, i.e. transmitting a target value (change of the target value in the process data) starts a new run.

An exception is, if the run should go to the same target than before. In this case, deassert the release (bit 4 of the control word) and assert it again. Bit 2 ("transfer target value") has to be set at the same time. The drive then moves on when the release bit is being asserted again.

#### NOTICE

Runs which involve specifically a block run (e.g. reference runs on block), may only be started with reduced torque (max. torque max. 10% of the nominal torque, resp. the lowest possible value).

#### 5.4 Readjustment in case of manual displacement externally

If after a correctly finished positioning run (or a manual run to the range limit) during standstill the PSx3xx is displaced by external force opposite to the loop direction and the release bit (bit 4 in the control word) is set and the readjustment function (Par. 47) is enabled, the device will attempt to reach the previously transmitted target value once again (readjustment). After successful readjustment bit 0 will be set again. The device does not attempt to readjust if rotated in the loop direction; it merely sets bit 11 in the status word ("manual displacement") and resets bit 0 ("target position reached"). If the loop run is disabled (Par. 45 is 0), the drive readjusts the position in both directions.

#### NOTICE

If at standstill the drive continuously loses its position, the attempt to readjust starts exactly when the actual position is leaving the positioning window (assumed that all the conditions above are being fulfilled). The motor power has to be in a valid range at the time when this transition happens (e.g. Bit 4 in the status word is being set). If the motor power is missing at that time, the readjustment fails and bits 10 ("positioning error") and 13 ("motor power was missing") will become active. If later the motor power comes back again (after leaving the positioning window), there will be **no** further attempt to readjust. This is to prevent a situation that suddenly a drive begins to run if motor power is being switched on.

If an ongoing positioning run or manual run is aborted (release bit in the control word to 0), the drive readjusts the position not before a new run is being sent and finished successfully.

Deasserting the release bit and/or disabling the readjustment function can completely disable the readjustment process.

Drives with a brake generally don't have a readjustment function.

#### 5.5 Calculating the absolute physical position

The PSx3xx actuator includes an absolute measuring system with measurement range of 256 rotations. In order to avoid an overflow when the drive is switched off and moved by an external force, the user can only command positionings in the range of 250 rotations. Thus the upper as well as the lower 3 rotations of the measurement range are inaccessible.

The mapping of the desired positioning range to the physical positioning range is done with the help of the parameter "upper mapping end" (Par. 41).

In the delivery state, the drive is at position 51200, the upper limit switch is set to 101200 and the lower limit switch is set to 1200, yielding a positioning range of  $\pm 125$  rotations ( $\pm 50000$  increments). So if the desired positioning range doesn't exceed  $\pm 125$  rotations, in delivery state none of the following actions to adjust the positioning range have to be taken.

For the realization of any desired positioning range independent of the possible positioning range which is defined by the mounting situation (physical positioning range) there are the following two possibilities:

- 1) Move the axle (for example a spindle) to the desired position, then move the drive (with opened collar) to the position value which belongs to the physical position of the axle, only then close the collar.

Examples:

- a) Move the axle in middle position, then move the drive at no-load (with opened collar) also to middle position (position 51200), then close the collar. The drive is now capable of moving 125 rotations ( $\pm 50000$  increments by default) in each direction.
  - b) Move the axle completely to the left (resp. bottom), then move the drive at no-load (with opened collar) without loop to the lowest position (position 1200), then close the collar. The drive is now capable of moving 250 rotations (100000 increments by default) to the right (resp. top).
  - c) Move the axle completely to the right (resp. top), then move the drive at no-load (with opened collar) to the highest position (position 101200), then close the collar. The drive is now capable of moving 250 rotations (100000 increments by default) to the left (resp. bottom).
- 2) Mount the drive in any position on the axle, close the collar, then adjust the positioning range with the help of Par. 41. Par. 41 defines the upper end of the positioning range. By default, the upper end is at +256 rotations (position 102400). If the positioning range doesn't suit to the actual displayed position after mounting the drive, the upper end of the positioning range can be adjusted freely between +3 rotations and +253 rotations (measured from the actual position).

Examples:

- a) After mounting the drive, the displayed position is 51200 (which corresponds the delivery state). But the positioning range shall solely spread to the right (resp. top).
  - upper mapping end = actual position + 253 rotations
  - Set Par. 41 to 152400
- b) After mounting the drive, the displayed position is 100000. But the positioning range shall solely spread to the right (resp. top).
  - upper mapping end = actual position + 253 rotations
  - Set Par. 41 to 201200
- c) After mounting the drive, the displayed position is 2000. But the positioning range shall solely spread to the left (resp. bottom).
  - upper mapping end = actual position + 3 rotations
  - Set Par. 41 to 3200

Remarks:

- 1) When calculating the upper mapping end (Par. 41), a security reserve of 3 rotations has to be kept in mind (1200 increments by default, see the examples above), because the highest possible position value is 3 rotations below the upper mapping end. The lowest possible position value is 253 rotations below the upper mapping end.
- 2) The above given increment and position values relate to the following settings, which correspond to the delivery state:
  - a) position scaling, numerator (Par. 38) = 400
  - b) position scaling, denominator (Par. 39) = 400
  - c) referencing value (Par. 40) = 0
 These 3 parameters have an influence on the above given increment and position values: With the help of the referencing value a shift can be reached, with the help of the position scaling numerator and denominator a stretching or distension can be reached (see below).
- 3) When changing the direction of rotation (Par. 37), the referencing value (Par. 40), the upper mapping end (Par. 41) and the upper and lower limit (Par. 42 and 43) are set to delivery state.

- 4) When changing the upper mapping end (Par. 41), the upper limit (Par. 42) will be set to the value [upper mapping end - 3 rotations x scaling] and the lower limit (Par. 43) to the value [upper mapping end - 253 rotations x scaling]. This results in a positioning range of 250 rotations.
- 5) When changing the position scaling numerator or denominator (Par. 38 or 39), the target value, the actual value, the referencing value, the upper mapping end, the upper and lower limit, the drag error, the positioning window and the length of loop are re-calculated.
- 6) When changing the referencing value (Par. 40), the target value, the actual value, the upper mapping end and the upper and lower limit are re-calculated.  
If the values of the upper mapping end (par. 41) and/or the limit switches (par. 42, 43) are sent by default each time the unit starts up, the new referencing value must be included in these values if necessary. This can be done, for example, by defining base values (which apply in the case of "referencing value = 0"), to which the respective current value of the referencing value is then added.
- 7) If the user wants to go over any automatic re-calculation of values when setting up the device, the optimum order of transferring the parameter is the following:
  - a) direction of rotation (Par. 37),  
position scaling, numerator (Par. 38),  
position scaling, denominator (Par. 39)
  - b) referencing value (Par. 40)
  - c) upper mapping end (Par. 41)
  - d) upper limit (Par. 42),  
lower limit (Par. 43),  
positioning window (Par. 44),  
length of loop (Par. 45),  
drag error (Par. 46)
- 8) In order to save the settings permanently in the EEPROM, write 1 to Par. 96. As soon as reading of Par. 96 shows 0, the saving is finished.

#### Referencing value (Par. 40):

With the help of the referencing value (Par. 40) a shift of the whole range of values can be reached. The referencing process affects all transferred values, i.e., the target value, actual value, upper mapping end and upper and lower limit.

There are two ways of setting the referencing value:

- 1) Directly, by writing the referencing value to Par. 40.
- 2) Indirectly, by writing an actual value to Par. 3. This makes it possible to assign any "true" actual value to the current, physical actual value. The resulting difference is then the referencing value. This value will immediately be included in calculations for each transferred value and can also be read via Par. 40.

When changing the referencing value, automatically the target value, the actual value, the upper mapping end and the upper and lower limit are re-calculated.

#### **NOTICE**

The removal of the **motor** power supply has no affect on the internal measuring system.

## 5.6 Use of the “Upper mapping end” parameter

The following chapter illustrates the use of the parameter “upper mapping end” both graphically and by means of examples:

### 5.6.1 Delivery state

In the delivery state (“DS”), the actual position is exactly in the middle of the positioning range. There is a safety margin of three rotations at the output shaft at both the lower and upper ends of the positioning range. The device with the error “Incorrect target value” rejects positioning runs that extend into these safety margins.

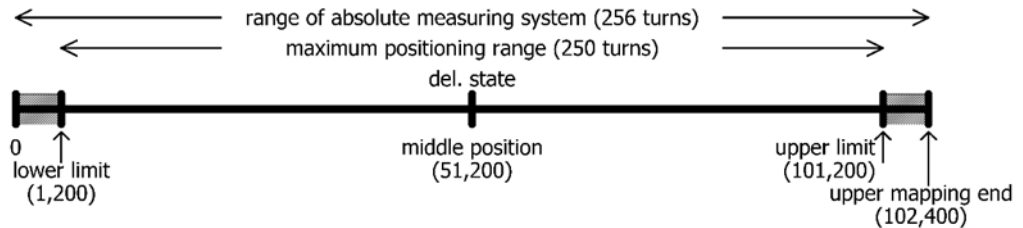

In the delivery state, the values from the following table result for the upper mapping end and the lower and upper limits:

Upper mapping end	102,400
Lower limit	1,200
Upper limit	101,200

Positioning range symmetrical to 51,200

Starting from this state, the maximum possible positioning range can now be shifted upwards or downwards as required.

It is important to note that after the device has been installed, the available positioning range may not be sufficient in one of the two directions. The parameter “upper mapping end” now allows you to reduce the positioning range in one direction and increase it in the other direction.

### 5.6.2 Shifting the positioning range upwards starting from the delivery state

In the following example, starting from the DS, the maximum possible positioning range is shifted slightly upwards using the parameter “upper mapping end”:

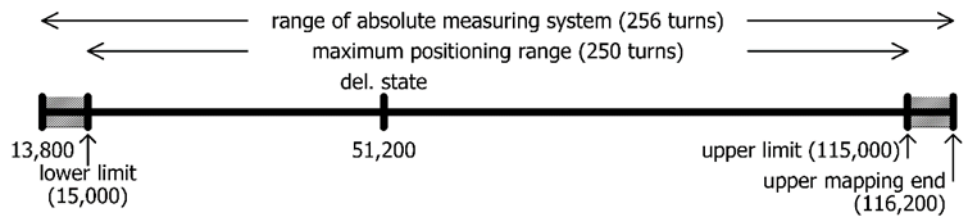

Here, the upper mapping end was increased from the value 102,400 to 116,200. Consequently, a higher proportion of the possible positioning range is above 51,200 and a smaller proportion below 51,200.

In the extreme case, the upper mapping end can be set so that the entire possible positioning range is at values  $\geq 51,200$ . With standard scaling (numerator = denominator = 400, i.e. 1 step =  $0.9^\circ$ ) and referencing value = 0, this special case results if the relevant value from the following table is selected for the upper mapping end. The device then automatically adjusts the lower and upper limits accordingly.

Upper mapping end	152,400
Lower limit	51,200
Upper limit	151,200

Positioning range starts at 51,200

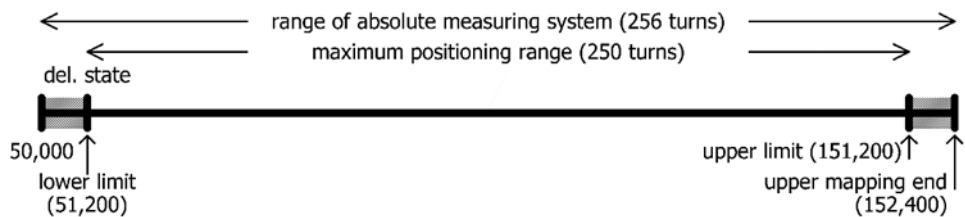

#### NOTICE

The numerator factor and denominator factor can be used to map any spindle resolutions. Using the referencing value, you can shift the whole range of values.

### 5.6.3 Shifting the positioning range downwards starting from the delivery state

In the following example, starting from the DS, the maximum possible positioning range is shifted slightly downwards using the parameter “upper mapping end”:

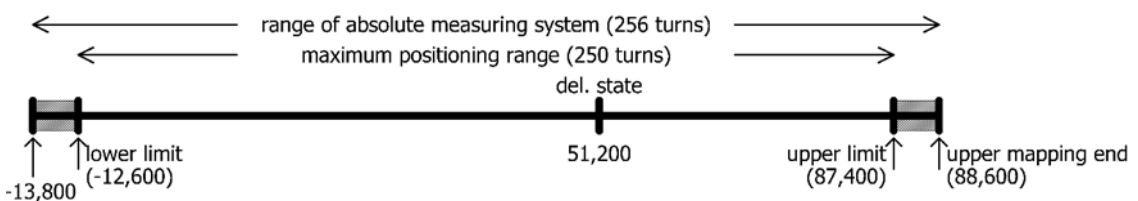

Here, the upper mapping end was decreased from the value 102,400 to 88,600. Consequently, a higher proportion of the possible positioning range is below 51,200 and a smaller proportion above 51,200.



In the extreme case, the upper mapping end can be set so that the entire possible positioning range is at values  $\leq 51,200$ . With standard scaling (numerator = denominator = 400, i.e. 1 step =  $0.9^\circ$ ) and referencing value = 0, this special case results if the relevant value from the following table is selected for the upper mapping end. The device then automatically adjusts the lower and upper limits accordingly.

Upper mapping end	52,400
Lower limit	-48,800
Upper limit	51,200

Positioning range ends at 51,200

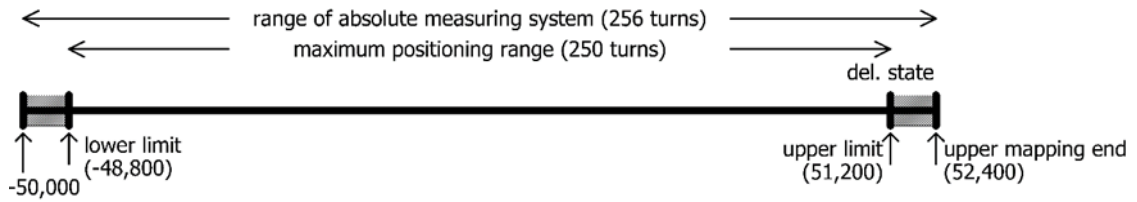

### 5.6.4 Shifting the positioning range depending on the actual position

If (in contrast to the examples above) the actual position is not in the delivery state (i.e. value 51,200), this is included in the calculation of the possible value range for the upper mapping end. The decisive factor is that the device only accepts values for the upper mapping end where the actual position is within the max. possible positioning range after the upper mapping end has been set (due to rounding effects with a max. difference of 1 step), i.e. the following applies after setting the upper mapping end:

$$[\text{lower limit} - 1] \leq \text{actual position} \leq [\text{upper limit} + 1]$$

Please note that the measurement range of the absolute encoder is 256 rotations at the output shaft. Together with the safety margins at the upper and lower end of the measurement range, the following value range results for the upper mapping end:

$$\text{Minimum value for upper mapping end} = \text{actual position} + 1,200 * \text{denominator} / \text{numerator}$$

$$\text{Maximum value for upper mapping end} = \text{actual position} + 101,200 * \text{denom.} / \text{numerator}$$

The following formulas result for the special case numerator = denominator:

$$\begin{aligned} \text{Minimum value for upper mapping end} &= \text{actual position} + 1,200 \\ \text{Maximum value for upper mapping end} &= \text{actual position} + 101,200 \end{aligned}$$

(This is the case, e.g. for the delivery state where numerator = denominator = 400.)

#### NOTICE

Since the upper mapping end is an integer, the minimum and maximum values are obtained by rounding to the nearest integer (applies only to the case numerator  $\neq$  denominator).

#### Example:

- Spindle with 5 mm pitch, specified unit for target and actual values: 1 $\mu$ m  
     → 1 rotation = 5mm = 5,000 $\mu$ m  
     → Number of steps per rotation = 5,000
- Using the formula  

$$\text{Number of steps per rotation} = 400 * \text{denominator} / \text{numerator}$$
     the following result is obtained:  
     numerator = 400; denominator = 5,000
- With these settings, the drive is mounted and run using manual positioning commands, to a defined physical position (e.g. a specific mark along the run path) at which the actual position is to assume a specific value, e.g. the value 0.
- In our case, the position after running to this defined physical position shows, for example, the value 300,000. In this position, the actual value is set to zero. The device uses this information to calculate the new referencing value at 300,000.  
     → Referencing value = 300,000
- The drive has a positioning range of 250 rotations (see above: Measurement range of the absolute encoder minus a safety margin of three rotations at both ends of the measurement range).

- In our case, these 250 rotations are to be divided in such a way that the drive can run 10 rotations (=  $10 * 5,000$  steps = 50,000 steps) from the zero position, just defined, to smaller values and 240 rotations (=  $240 * 5,000$  steps = 1,200,000 steps) to larger values.
- To ensure that the position value 1,200,000 is at the upper end of the maximum possible positioning range, as specified (i.e. at the upper limit), we add the safety margin of three rotations to this value and thus obtain our value for the upper mapping end:  
upper mapping end =  $1,200,000 + 3 * 5,000 = 1,215,000$
- The device then recalculates the positioning range limits:  
lower limit = upper mapping end -  $253 * 5,000 = -50,000$   
upper limit = upper mapping end -  $3 * 5,000 = 1,200,000$
- This positioning range can then be restricted as required, i.e. the lower limit can be increased and the upper limit can be reduced.

### 5.6.5 Step-by-step instructions for determining the positioning range

The following section describes the procedure for determining those parameters that have an influence on the target and actual position as well as the positioning range. The individual steps must be carried out in the specified order.

1) Setting the direction of rotation:

The direction of rotation determines with which direction of rotation of the output shaft the position values increase and with which direction of rotation of the output shaft the position values decrease.

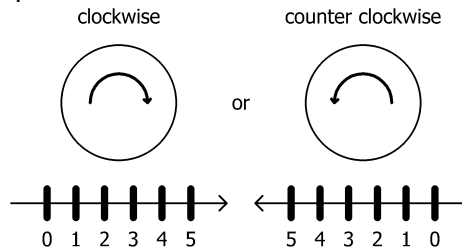

2) Setting numerator and denominator:

The numerator and denominator determine the number of steps into which one rotation of the output shaft is divided.

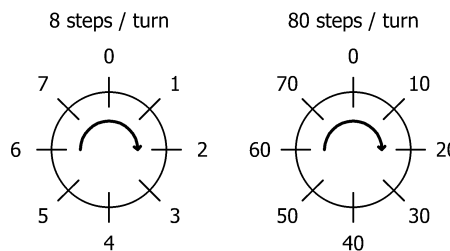

3) Setting referencing value:

The referencing value is used to assign a specific value of the actual position to a specific physical position of the axle.

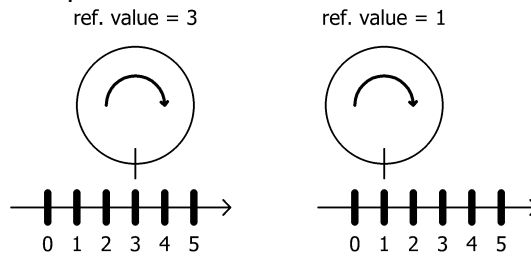

The referencing value is written either directly or by setting the actual position.

4) Setting upper mapping end:

The parameter defines the location of the maximum possible positioning range, taking into account the scaling values and the referencing value.

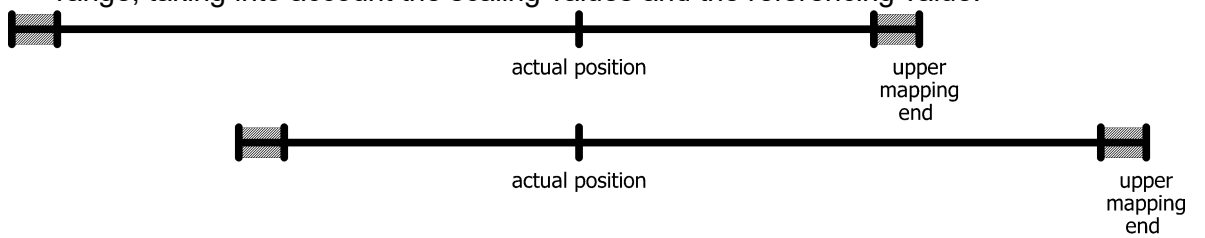

5) Setting upper and lower limits:

If necessary, the maximum possible positioning range can be restricted to prevent incorrect target positions that lead to a collision.

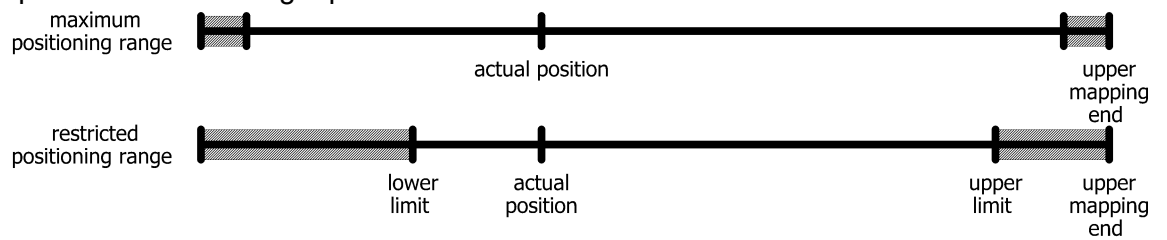

## 5.7 Using position scaling factors to set the spindle pitch

Par. 38 (numerator factor) and Par. 39 (denominator factor) can be used to represent any desired spindle pitch:

$$\text{number of steps per revolution} = 400 * \frac{\text{denom. factor}}{\text{numerator factor}}$$

Both factors are set to a value of 400 by default, resulting in a resolution of 0.01 mm at a spindle pitch of 4 mm.

The denominator factor serves as a simple means of setting the spindle pitch and resolution.

The numerator factor is primarily used for setting “unlevel” resolutions.

Examples:

Spindle pitch	Resolution	Numerator factor	Denominator factor
4 mm	1/100 mm	400	400
1 mm	1/100 mm	400	100
2 mm	1/10 mm	400	20

Numerator and denominator factors may take on values between 1 and 10,000.

## 5.8 Drag error monitoring

During a positioning run, the device compares the computed target position with the current actual value. If the difference is larger than the “drag error” value (Par. 46), the device sets the corresponding bit in the status word. This situation is especially likely to occur if external factors (required torque, voltage to motor too low) prevent the device from achieving the target rpm.

By setting Par. 46 to 0 the drag error monitoring can be disabled.

## 5.9 Drag error correction

With Par. 48 the drag error correction can be enabled. With this feature enabled, the drive will raise or lower the target speed proportional to the drag error by the configured value. The drive attempts under consideration of the configured maximum current to compensate the drag error which has developed by controlling the target speed to a value which lays slightly above or below the specified value of the target speed (Par. 53).

By setting Par. 48 to 0 the drag error correction can be disabled.

Drag error monitoring and correction take effect always except during a braking operation when approaching a target position or when aborting a positioning. The actual target speed when accelerating is determined by the actual speed at the beginning of the positioning and the acceleration setting (Par. 58).

## 5.10 Response at power up, at “IOPS = BAD” and at connection timeout

### Behaviour at power-up (apply power to the control unit):

The behaviour is defined by bits 3-2 of Par. 93. There are basically two types of behaviour:

- 1) The drive enters the holding state.  
→ This behaviour is enabled if bits 3-2 of Par. 93 (“configuration for connection timeout”) is set to 0x00.

- 2) The drive moves to the safety position.  
→ This behaviour is enabled if bits 3-2 of Par. 93 (“configuration for connection timeout”) is set to a value > 0:

0x01: safe position run after 15 sec

0x02: safe position run after 30 sec

0x03: safe position run after 60 sec

The safety position is the position which is defined with Par. 94.

The run to the safety position starts after the specified time has elapsed since the power-up of the unit (i.e. after 15, 30 or 60 sec.).

The safe position run can also be started repeatedly in case of failure, this is configured by Par. 95 (“repetition time for safe position run”).

If the connection to the IO controller is established during the run to the safety position, the drive aborts the safe position run and enters the holding state. From now on it's possible to send run commands.

### Behaviour if IOPS = BAD (e.g. if the PLC is in the state “CPU Stop”):

The behaviour is defined by bits 5-4 of Par. 93. There are basically three types of behaviour:

- 1) If currently a positioning is in progress, the drive terminates this positioning as planned and then does not start a new positioning as long as the state “IOPS = BAD” remains.  
→ This behaviour is enabled if bits 5-4 of Par. 93 (“configuration for connection timeout”) is set to 0x00 (“continue moving”).

- 2) If currently a positioning is in progress, the drive aborts the movement and then does not start a new positioning as long as the state “IOPS = BAD” remains.  
→ This behaviour is enabled if bits 5-4 of Par. 93 is set to 0x01 (“abort positioning”).

If the process data contain valid values in case of a change of IOPS to “GOOD” (e.g. if the PLC is again in the state “CPU Run”), the drive continues to run immediately if applicable.

- 3) Irrespective of whether the drive is at a standstill or whether a positioning is in progress, the drive moves to the safety position.  
→ This behaviour is enabled if bits 5-4 of Par. 93 is set to 0x02 (“move to safe position”).

The safety position is the position which is defined with Par. 94.

The safe position run can also be started repeatedly in case of failure, this is configured by Par. 95 (“repetition time for safe position run”).

If the value of IOPS changes to “GOOD” again during the run to the safety position (e.g. if the PLC is again in the state “CPU Run”), the drive aborts the safe position run and enters the holding state. From now on it's again possible to send run commands.

### Behaviour in case of a connection loss to the IO controller:

The behaviour is defined by bits 1-0 of Par. 93. There are basically three types of behaviour:

- 1) If currently a positioning is in progress, the drive terminates this positioning as planned and then does not start a new positioning as long as there is no connection.  
→ This behaviour is enabled if bits 1-0 of Par. 93 ("configuration for connection timeout") is set to 0x00 ("continue moving").
- 2) If currently a positioning is in progress, the drive aborts the movement and then does not start a new positioning as long as there is no connection.  
→ This behaviour is enabled if bits 1-0 of Par. 93 is set to 0x01 ("abort positioning").  
If the process data contain valid values when the connection is re-established, the drive continues to run immediately if applicable.
- 3) Irrespective of whether the drive is at a standstill or whether a positioning is in progress, the drive moves to the safety position.  
→ This behaviour is enabled if bits 1-0 of Par. 93 is set to 0x02 ("move to safe position").  
The safety position is the position which is defined with Par. 94.  
The safe position run can also be started repeatedly in case of failure, this is configured by Par. 95 ("repetition time for safe position run").  
If the connection to the IO controller is re-established during the run to the safety position, the drive aborts the safe position run and enters the holding state. From now on it's again possible to send run commands.

## 5.11 Devices with "Jog keys" option

External jog buttons can be used to move the drive when the bus connection is inactive.

When the bus connection is active, the external jog buttons can be enabled via bits 3 and 5 in the control word (see section 3.11.5 Detailed description of control bits).

The step size for short keystrokes can be set via parameter 49. A single step is executed when one of the external keys is pressed. If the key is released before the single step has been completed, it will still be completed. If the same key remains pressed, the single step may be followed by a continuous manual movement after a short waiting time, which continues as long as the key is pressed. The waiting time until the drive changes over to manual travel is set with parameter 74. In manual travel, the drive moves to the respective limit switch position (parameter 42 or 43).

If both keys are pressed during a jog movement, the movement is aborted immediately. A new inching movement is only possible again when both keys have been released.

### **Connecting the Jog Key Inputs**

The jog key inputs can be used in 2 different wiring modes:

#### - Connection of potential-free switches

To activate the respective jog key input, the +24V in the jog key plug is connected here.

The GND connection in the jog key plug remains unused.

The 24V output in the jog key plug is internally connected to the +24V control in the supply plug. It is therefore also possible to connect the jog button inputs directly to the +24V control potential via switches.

**- Connection of an active signal**

Here the respective jog key input is connected to the (active) signal connection. The reference ground of the external active signal should be connected to the GND connection in the jog key plug. The +24V output in the jog key plug remains unused. The GND connection in the jog key plug is internally connected to the GND control in the power supply plug. If the connected active jog key signal has the same GND potential as the GND control, the wiring of the GND connection in the jog key plug can be omitted.

Connection examples:  
potential-free switches

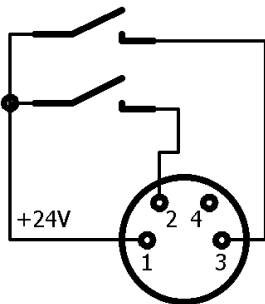

active signals e.g. from a PLC

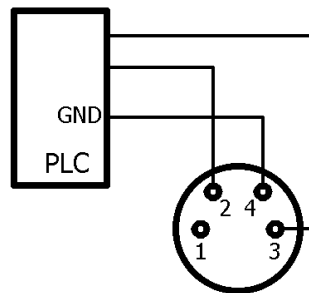

**5.12 Manual turning with the adjustment facility**

When mounting or dismounting a PSx3xx, it may be necessary to manually turn the output shaft to a certain position. For this purpose, the actuators are equipped with a manual adjustment facility:

First, the corresponding cover in the cover must be removed.

Then use a NW3 (PSx31x, PSx33x, or NW4 (PSx30x, PSx32x) hexagon key to disengage the brake by pressing it down and turn it simultaneously.

An electrical release of the brake via bus is not possible on its own (without travel job).

<b>⚠ CAUTION</b>
The drive must not be turned into another position with an electric screwdriver.

<b>⚠ CAUTION</b>
Important: Always replace the protective cap after setting the address. This will prevent dust and contaminants from entering the instrument.

<b>⚠ CAUTION</b>
A "forced" turning of the drive without disengaging the brake leads to the destruction of the brake and thus of the drive!



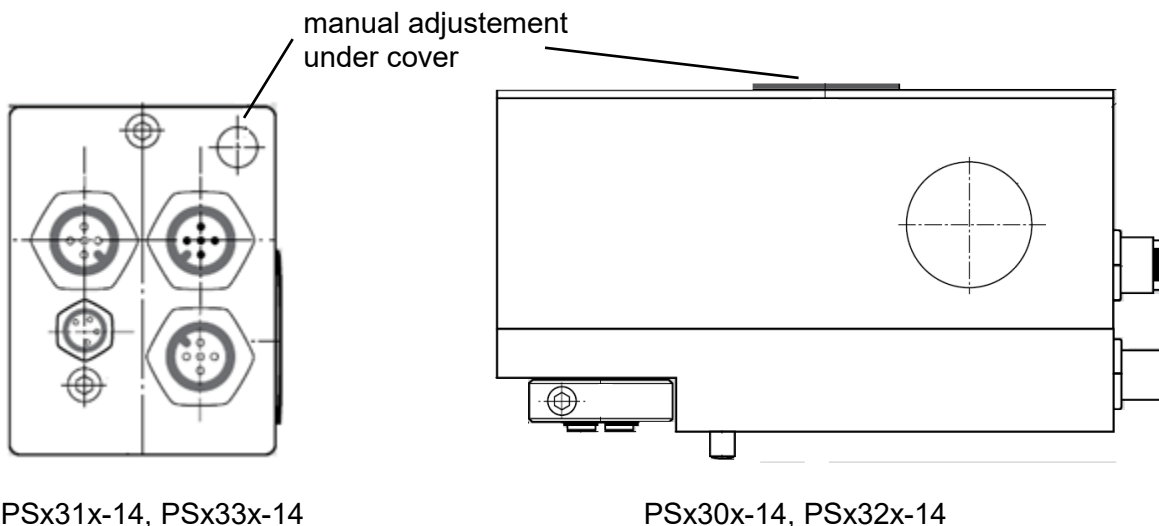

### 5.13 Devices with optional snap brake

The device models PSx30x-14, PSx31x-14, PSx32x and PSx33x can be supplied with an optional snap brake. This brake prevents the output shaft from turning when the power supply to the motor is removed, or, if the motor holding torque is too low, to a maximum of the level of the nominal torque. A small degree of rotation always occurs at the output, i.e. the brake cannot be used to hold the drive at a defined position (for this purpose the holding torque may have to be increased with the help of Par. 65 and Par. 66).

To release the brake when a run command is transmitted, these devices first wait for a short time and then run a few increments against the actual direction of movement. The brake is closing at the end of every run (by default 1 sec after the end of the run, Par. 75). The advantage of this feature is, that in case of many subsequent runs the brake has not to be released anew each time.

### 5.14 Devices with optional holding brake

The device model PSE34xx can be supplied with an optional holding brake. This brake prevents the output shaft from turning when the power supply to the motor is removed, or, if the motor holding torque is too low.

A run command is not approached immediately but only after a short idle period to tighten the brake.

The brake releases at the end of every run.

To adjust the drive manually, it is first necessary to remove the corresponding rubber-plug in the top cover (see drawings at the end of these instructions). The drive can then be rotated using a hex wrench NW4. This is quite difficult as the operator has to overcome both any torque present at the output and the force of the friction brake. The brake is not damaged by manual rotation.

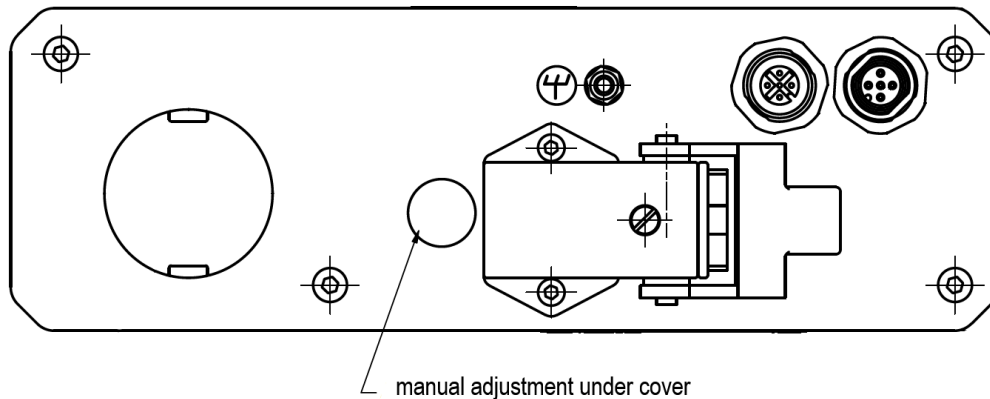

### 5.15 Reference runs

The PSx3xx positioning system is equipped with an absolute measuring system, therefore there's no need for a reference run when powering on the drive. However, if in certain cases a reference run onto a hard block should be desired (e.g. uniquely when installing the drive at a machine), the course of action should be the following:

- 1) Before commanding the reference run the following settings have to be carried out:
  - set the maximum torque (Par. 64) and the maximum start-up torque (Par. 63) to max. 10% of the nominal torque, resp. the lowest possible values
  - set the maximum holding torque (Par. 66) and the maximum holding torque at end of run (Par. 65) to 0
  - set the rpm limit for aborting run (Par. 57) to 60
  - set the time elapsed until speed falls below rpm limit for aborting run (Par. 70) to 100  
(The span of time in which the drive tries to get over the block, decreases: With the reduced values the positioning will be aborted if the speed stays below 60% of the target speed for longer than 100ms. By default, these values are 30% and 200ms.)
  - set the corresponding upper and lower limit (Par. 42 or 43) in a way that the block location lays considerable within the area between the upper and lower limit  
(Otherwise there's the danger that the block is located within the positioning window and consequently won't be recognized.)
  - Where appropriate, reduce the target speed for manual run (Par. 56).
- 2) Now start the reference run as manual run, i.e. set bit 0 or 1 and the release bit (bit 4) in the control word.
- 3) Wait for the drive moving (bit 6 in the status word is set).
- 4) Wait for the drive has stopped and a positioning error has appeared (bit 6 in the status word is cleared, bit 10 is set).
- 5) Start a manual run in the opposite direction with the same settings (move a certain distance away from the hard stop in order the drive can move freely).
- 6) Only now adjust the desired settings of the above mentioned parameters for normal operation.

## 5.16 Reverse drive

In vertical positioning with spherical roller spindles, pitches of approx. 4..10 mm and weights from 100 kg, it is possible that the PSx3xx does not consume any energy from the motor supply when travelling downwards, but rather generates some. This regenerative operation is permissible under certain conditions. The energy generated is fed back into the motor supply network via the internal regenerative circuit and must be drawn off there. The PSx3xx increases the voltage in the motor supply network until the additional energy is drawn off. However, the internal protection diode limits this voltage to max. 31 VDC.

The following cases should be considered:

- 1) If several PSx3xx and/or other loads are connected to the same power supply, regeneration is possible without any additional measures if several PSx3xx do not generate power simultaneously. The other devices then act as consumers of the energy generated by a PSx3xx.
- 2) If several PSx3xx are to use the regenerative circuit simultaneously, an overvoltage protection must be provided in the motor supply network.

If a PSx3xx is operated for more than 1-2 seconds in regenerative mode without consumer of the generated energy, this damages the internal protection diode and the PSx3xx is defective.

## 6. Technical Data

### 6.1 Ambient conditions

ambient temperature	0 °C to +45 °C		
storage temperature	-10 °C to +70 °C		
shock resistance according to DIN IEC 60068-2-27	50 g 11 ms		
resistance to vibration according to DIN IEC 60068-2-6	10 Hz to 55 Hz 1,5 mm 55 Hz to 1000 Hz 10 g 10 Hz to 2000 Hz 5 g		
EMC standards	CE		
conformity	CE / UKCA		
protection class	PSE	IP 54 / IP65	
	PSS	IP 65	
	PSW	IP 66 (in operation) IP 68 (at standstill)	
duty cycle	Device model	Duty cycle in %	Base time in sec.
	PSE34xx	20	300
	PSE30xx to 33xx	30	300
	PSS	20	600
	PSW	20	600

### 6.2 Electrical data

nominal power output	PSx30x, PSx31x, PSE31xx	25 W mit 30 % ED
	PSx32x, PSx33x	35 W mit 30 % ED
	PSE34xx	100 W mit 20 % ED
supply voltage	24 VDC ±10 % (supply voltages for motor and control unit are galvanically isolated) advice: use regulated power supplies	
nominal current, control unit	0.15 A	
nominal current, motor	PSx30x, PSx31x, PSE31xx	2.4 A
	PSx32x, PSx33x, PSE32xx, PSE33xx	3.1 A
	PSE34xx	7.8 A
positioning resolution	0.9°	
positioning accuracy	0.9°	
protocol	PROFINET (IEC 61158-6-10)	
absolute value acquisition	optical - magnetic	

### 6.3 Physical data

positioning range	250 usable rotations, no mechanical limits measuring system has a span of 256 turns, minus 3 turns security stock at upper and lower range limit	
torsional rigidity (angle of rotation when switching from operation without backlash to maximum torque)	max. 0.2°	
gear backlash (without spindle compensation run)	max. 0.5°	
spindle lash compensation	automatic loop after every positioning run (may be deactivated)	
output shaft	PSE30x-8, PSE31x-8	8H9 hollow shaft with adjustable collar
	PSE30x-14, PSE31-14, PSE32x-14, PSE33x-14	14H7 hollow shaft with adjustable collar
	PSE31xx-14, PSE34xx-14	14h7 hollow shaft with clamp and feather key
	PSS3xx-8 PSW3xx-8	8H9 hollow shaft with adjustable collar or 8h8 solid shaft
	PSS3xx-14, PSW3xx-14	14H7 hollow shaft with adjustable collar or 14h8 solid shaft
recommended diameter of the spindle head	according to the hollow shaft diameter with an interference fit of h9	
Vibration emission	not in the harmful range	
Noise emission	not in the harmful range	
maximum radial force	40 N	
maximum axial force	20 N	
dimensions (l x w x h)	see drawings	
weight (approx.)	PSx30x-8	650 g
	PSx30x-14, PSx32x-14	1200 g
	PSx31x-8	700 g
	PSx31x-14, PSx33x-14	700 g
	PSE31xx-14	1200 g
	PSE34xx-14	1900 g

For additional specifications and dimension drawings, please visit our website at  
<https://www.halstrup-walcher.de/en/products/drive-technology/>



## 7. Certificates of Conformity



### EU-Konformitätserklärung EU Declaration of Conformity

- Company** halstrup-walcher GmbH, Stegener Str. 10, 79199 Kirchzarten  
erklärt als Hersteller in alleiniger Verantwortung, dass das Produkt  
declares as manufacturer under sole responsibility, that the product
- Product** Positionierantriebe Baureihen PSE3xx, PSS3xx, PSW3xx  
Positioning Systems Series PSE3xx, PSS3xx, PSW3xx
- Regulations** den folgenden Europäischen Richtlinien entspricht:  
conforms to following European Directives:  
EMC 2014/30/EU  
RoHS 2011/65/EU
- Standards** angewandte harmonisierte Normen:  
applied harmonized standards:  
EN IEC 61800-3:2018  
EN IEC 63000:2018
- Certification** EU Konformitätserklärung ausgestellt von  
EC Type Examination Certificate issued by



Geschäftsführer

Managing Director

Kirchzarten,

14. Okt. 2020

14. Oct. 2020

halstrup-walcher GmbH  
Stegerer Straße 10  
79199 Kirchzarten

Telefon: +49 (0) 7661 3963-0  
Fax: +49 (0) 7661 3963-99  
E-Mail: info@halstrup-walcher.de

Geschäftsführer: Jürgen Walcher, Christian Sura  
Handelsregister Freiburg HRB 2209  
Umsatzsteuer-ID-Nr. DE 811169901



## UK Declaration of Conformity

**Company** halstrup-walcher GmbH, Stegener Str. 10, 79199 Kirchzarten, Germany  
declares as manufacturer under sole responsibility, that the product

**Product** Positioning System Models PSE3xx / PSS3xx / PSW3xx

**Regulations** is in conformity with relevant statutory requirements:

EMC Electromagnetic Compatibility Regulations 2016 No. 1091  
RoHS RoHS Regulations 2012 No. 3032

**Standards** applied standards:

EN 55011:2016+A1:2017; EN 61000-6-2:2005; EN 61800-3:2004/ A1:2012  
EN IEC 63000:2018

**Declaration** signed for and on behalf of

Geschäftsführer

Managing Director

Kirchzarten, 26. Jan. 2022