



---

# Instruction Manual

## PSx3xxDN

---



halstrup-walcher GmbH

Stegener Straße 10  
D-79199 Kirchzarten

Phone: +49 (0) 76 61/39 63-0

E-Mail: [info@halstrup-walcher.com](mailto:info@halstrup-walcher.com)

Internet: [www.halstrup-walcher.com](http://www.halstrup-walcher.com)

## Revision overview

Version:	Date:	Author:	Content:
N	12.12.22	Ka	
O	12.04.23	Ts	revise manual, new chapter 2.3 powering device, chapter 2.2.installation: detailed description added, detailed description of status bits revised,
P	10.08.23	Ts	Chapter 4 - Behaviour of the actuator during manual rotation added, reference mapping extended, new chapter 4) upper mapping end, QR code measurement technology, current consumption "Electrical data" corrected. New chapter Limitation of liability and cross-sections Power supply cables. Reference to axial and radial forces in chap. assembly.
Q	19.06.24	Ts	Error corrections, safety topics, meaning of the operating instructions revised, intended and non-intended use added, limitation of liability revised, new product labeling, assembly chapter revised, vibration and noise emissions in Physical Data added

Translation of the original instructions

© 2024

The manufacturer owns the copyright to this instruction manual. It contains technical data, instructions and drawings detailing the devices' features and how to use them. It must not be copied either wholly or in part or made available to third parties.

These operating instruction is part of the product. Read these instructions carefully, follow our instructions and pay particular attention to safety instructions. The instructions should be available at all times.

## Purpose of instruction manual

This instruction manual describes the features of the PSx3xx positioning system and provides guidelines for its use.

Every person who is tasked with carrying out work on or with the appliance must have read and understood the operating instructions before starting work on the appliance. This also applies if the person concerned has already worked with such an appliance or a similar appliance or has been trained by the manufacturer.

These appliances can pose a risk to persons and property due to improper use and incorrect operation. For this reason, every person entrusted with handling the appliances must be trained and aware of the dangers. The operating instruction and in particular the safety instruction contained therein must be carefully observed.

**Always contact the manufacturer if you do not understand any parts of these instructions.**

Handle these operating instructions with care:

- It must be kept within easy reach for the entire service life of the appliances.
- It must be passed on to subsequent personnel.
- Any supplements issued by the manufacturer must be included.

The manufacturer reserves the right to further develop this device type without documenting this in each individual case. Your manufacturer will be happy to provide you with information on the current status of these operating instructions.

## Conformity

This device is state of the art.

It complies with the statutory requirements of the EC and UK-directives.

This is documented by the CE and the UKCA mark being affixed.



## Accessoires PSx3xx series

We offer you the corresponding supply and data plugs for all unit types. Please contact our sales department, stating the complete type designation, at the following e-mail address

[Vertrieb@halstrup-walcher.de](mailto:Vertrieb@halstrup-walcher.de)

## Table of Contents

<b>REVISION OVERVIEW .....</b>	<b>2</b>
<b>PURPOSE OF INSTRUCTION MANUAL.....</b>	<b>3</b>
<b>1. SAFETY PRECAUTIONS .....</b>	<b>6</b>
1.1. QUALIFIED PERSONNEL .....	6
1.2. EXPLANATION OF SYMBOLS .....	6
1.3. APPROPRIATE USE .....	7
1.4. INAPPROPRIATE USE .....	8
1.5. LIMITATION OF LIABILITY .....	9
1.6. FAULTS, MAINTENANCE, REPAIR, DISPOSAL .....	9
1.7. PRODUCT LABELING .....	10
<b>2. DEVICE DESCRIPTION.....</b>	<b>11</b>
2.1. FEATURES .....	11
<b>3. INSTALLATION .....</b>	<b>12</b>
3.1. ELECTRICAL CONNECTION .....	12
3.2. ASSEMBLY OF THE POSITIONING SYSTEM.....	13
3.2.1. HOLLOW SHAFT.....	13
3.2.2. SOLID SHAFT .....	15
3.3. DISASSEMBLY .....	15
3.4. POWERING THE DEVICE .....	16
3.5. PIN ASSIGNMENT.....	16
3.5.1. SUPPLY VOLTAGE CONNECTOR (24VDC): .....	16
3.5.2. CONNECTOR FOR JOG KEYS: .....	17
3.5.3. ROUND PLUG AND SOCKET FOR CAN BUS: .....	17
3.5.4. ELECTRICAL GROUNDING (CHASSIS) .....	17
3.6. SETTING THE DEVICE ADDRESS AND BAUD RATE .....	18
3.7. START-UP.....	19
3.8. CAN Bus .....	20
3.9. TABLE OF IMPLEMENTED ATTRIBUTE ENTRIES .....	20
3.10. UCMM CONNECTION .....	30
3.11. EXPLICIT CONNECTION .....	30
3.12. I/O CONNECTIONS .....	31
3.13. MAPPING I/O ASSEMBLIES .....	31
3.14. ASSIGNING MAPPING I/O ASSEMBLIES TO AVAILABLE I/O CONNECTIONS .....	32
3.15. IDENTIFIERS USED FOR AVAILABLE I/O CONNECTIONS.....	32
3.16. DETAILED DESCRIPTION OF STATUS BITS .....	33
3.17. DETAILED DESCRIPTION OF CONTROL BITS.....	36
3.18. QUICK TEST FOR CHECKING THE DRIVE AND THE DEVICENET INTERFACE .....	38
<b>4. SEQUENCE OF POSITIONING STEPS.....</b>	<b>39</b>
4.1. POSITIONING SEQUENCE WITH LOOP .....	40
4.2. POSITIONING RUN WITHOUT A REFERENCE LOOP.....	41
4.3. MANUAL RUN .....	41
<b>5. SPECIAL FEATURES.....</b>	<b>42</b>
5.1. SPEED, ACCELERATION AND DECELERATION .....	42
5.2. MAXIMUM STARTING TORQUE AND MAXIMUM TORQUE.....	42
5.3. RESPONSE OF DRIVE IN CASE OF BLOCK OR MANUAL DISPLACEMENT .....	42
5.4. BEHAVIOUR OF THE ACTUATOR DURING MANUAL ROTATION (READJUSTMENT FUNCTION).....	43
5.5. CALCULATING THE ABSOLUTE PHYSICAL POSITION .....	43
5.6. USE OF THE "UPPER MAPPING END" PARAMETER .....	46
5.6.1. DELIVERY STATE .....	46
5.6.2. SHIFTING THE POSITIONING RANGE UPWARDS STARTING FROM THE DELIVERY STATE .....	46
5.6.3. SHIFTING THE POSITIONING RANGE DOWNWARDS STARTING FROM THE DELIVERY STATE .....	47
5.6.4. SHIFTING THE POSITIONING RANGE DEPENDING ON THE ACTUAL POSITION.....	48
5.6.5. STEP-BY-STEP INSTRUCTIONS FOR DETERMINING THE POSITIONING RANGE .....	50

5.7.	USING ACTUAL VALUE ASSESSMENT FACTORS TO SET THE SPINDLE PITCH.....	51
5.8.	DRAG ERROR.....	51
5.9.	ABORTED RUN WHEN THE MASTER FAILS .....	52
5.10.	OPTIONAL: MANUAL RUN USING EXTERNAL KEYS (JOG KEY MODE) .....	52
5.11.	MANUAL TURNING WITH THE ADJUSTMENT FACILITY.....	54
5.12.	DEVICES WITH OPTIONAL HOLDING BRAKE .....	55
5.13.	DEVICES WITH OPTIONAL FRICTION BRAKE.....	55
5.1.	REFERENCE RUNS .....	56
5.2.	REVERSE DRIVE.....	56
<b>6.</b>	<b>TECHNICAL DATA.....</b>	<b>57</b>
6.1.	AMBIENT CONDITIONS .....	57
6.2.	ELECTRICAL DATA.....	57
6.3.	PHYSICAL DATA.....	58
<b>7.</b>	<b>CERTIFICATE OF CONFORMITY.....</b>	<b>59</b>

## 1. Safety precautions

This section provides an overview of all the important safety aspects for optimum protection of personnel and for safe and trouble-free operation.

### 1.1. Qualified personnel



These operating instructions are intended for qualified electricians and fitters who are authorized to install, electrically connect, commission and label devices and systems in accordance with safety standards, as well as for the operator and manufacturer of the system on which the drives are installed.

The personnel must be provided with all applicable accident prevention and safety regulations that arise during commissioning or installation of the system.

It must be ensured that the personnel are familiar with all applicable accident prevention and safety regulations.

### 1.2. Explanation of symbols

In these operating instructions, the following highlights are used to draw attention to the hazards described below when handling the system:

 <b>DANGER</b>	<b>DANGER!</b> Indicates a situation of imminent danger, which will lead to a fatality or serious injuries if not prevented.
 <b>WARNING</b>	<b>WARNING!</b> Indicates a potentially dangerous situation, which may lead to a fatality or serious injuries if not prevented.
 <b>CAUTION</b>	<b>CAUTION!</b> Indicates a potentially dangerous situation, which may lead to minor/slight injuries if not prevented.
<b>NOTICE</b>	<b>NOTICE</b> Indicates a potentially harmful situation, which may lead to material damage if not prevented.

### 1.3. Appropriate use

Positioning systems are especially suitable for automatically setting tools, stops or spindles for wood-processing equipment, packing lines, printing equipment, filling units and other types of special machines.

PSx3xx positioning systems are not stand-alone devices and may only be used if coupled to another machine.



#### WARNING

Personal injury and property damage due to incorrect use of the products!

The positioning systems are designed for use in an industrial environment and may only be used as intended. If they are not used as intended, situations may arise that result in damage to property and personal injury.

#### NOTICE

The device is used as intended if all instructions and information in these operating instructions are observed.

- Only operate the device in perfect technical condition
- When attaching to a machine, observe the current safety regulations.
- Do not operate the product in all installed state unless all necessary protective measures have been taken.
- Observe the relevant regulations for the prevention of accidents (e.g. accident prevention regulations).
- In order to avoid the risk of accidents due to contact with moving parts, appropriate separating or non-separating guards must be provided.
- Use appropriate protective equipment (e.g. safety helmet, safety goggles, safety shoes, protective gloves).
- Use appropriate assembly and transport equipment.
- Store and transport the product in its original packaging, reuse protective caps for plugs if necessary.
- Adequate ventilation must be provided at the point of use to avoid excessive heating.
- During project planning, ensure that the device is always operated within its specifications. See technical data in chapter 6. Technical data.
- If the device is equipped with a brake, it is not a safety brake that may be used for safety functions.
- In special areas of application such as the chemical, pharmaceutical or food sector, the positioning system in stainless steel design is possible.

## 1.4. Inappropriate use

The use of the positioning devices outside of the operating conditions and technical data and specifications described in the documentation is considered “improper”.

The drives are designed for intended operation under normal ambient conditions (according to EN / IEC / UL 61010-1), with the exception of an extended temperature range.

- Operation inside buildings
- Operation at altitudes up to 2000m above sea level
- Ambient temperatures deviating from standard: 0°C to 45°C
- Maximum relative humidity 80% at temperatures up to 31°C, decreasing linearly to 50% relative humidity at 45°C
- Fluctuations in the supply voltage up to  $\pm 10\%$  of the nominal voltage at 50% relative humidity at 45°C
- The IP-protection rating is a manufacturer specification.

Any use of the device that goes beyond the intended use and/or is used differently can lead to dangerous situations

- Underwater usage of the PSW is not allowed
- The positioning system cannot be used for certain applications, such as the transport of people and animals or as a press-bending device for cold processing of metal.
- If the operation requirements stated in chapter 6. Technical data are exceeded, personal injury or property damage may occur.
- The positioning system cannot be used in hazardous areas.
- The holding brake must not be used to brake the motor.
- Under no circumstances may the housing cover be used for power transmission purposes, e.g. for supporting, climbing or similar.



## 1.5. Limitation of liability

The device may only be operated in accordance with these operating instructions. All information and instructions in these operating instructions have been compiled taking into account the applicable standards and regulations, the state of the art and our many years of experience and knowledge.

The manufacturer accepts no liability arising from improper or unintended use. Warranty claims also expire in this case:

- non-observance of the operating instructions
- improper use
- improper installation
- improper use
- Use by untrained personnel
- Modifications to the device
- Technical modifications
- Unauthorized modifications

The user is responsible for carrying out commissioning in accordance with the safety regulations of the applicable standards and all other relevant national or local regulations regarding conductor dimensioning and protection, grounding, circuit breakers, overcurrent protection, etc. The person who carried out the assembly or installation is liable for any damage caused during assembly or connection.

## 1.6. Faults, maintenance, repair, disposal

Faults or damage to the appliance must be reported immediately to the specialist personnel responsible for the electrical connection.









The appliance must be taken out of operation by the responsible specialist personnel until the fault has been rectified and secured against accidental use.

The appliance requires no maintenance.

Repair work that requires the housing to be opened may only be carried out by the manufacturer.

The electronic components of the appliance contain environmentally harmful substances and are also recyclable materials. The device must therefore be recycled after its final decommissioning. The environmental guidelines of the respective country must be observed.

## 1.7. Product labeling

Warning symbol	Meaning
	<p><b>Reference to further documentation</b> Read the operating instructions and safety instructions before transportation, installation or commissioning</p>
	<p><b>Warning of hot surface</b> The appliance can become very hot during operation. Temperatures of over 70°C can occur. In the event of a fault, internal components may be overloaded. Use personal protective equipment or wait long enough for the appliance to cool down.</p>
	<p><b>Warning of dangerous electrical voltage</b> Before working on the product, check that all power connections are de-energized!</p>
	<p><b>Disposal of batteries, electrical and electronic equipment</b></p> <ul style="list-style-type: none"> <li>• In accordance with international regulations, batteries, rechargeable batteries and electrical and electronic equipment must not be disposed of with household waste.</li> <li>• The owner is legally obliged to dispose of these devices properly at the end of their service life.</li> <li>• WEEE: This symbol on the product, its packaging or in this document indicates that a product is subject to these regulations.</li> </ul>
	<p><b>CE marking</b> CE stands for "Conformité Européenne". The CE marking expresses the conformity of a product with the relevant EC directives.</p>
	<p><b>UKCA marking</b> UKCA stands for "UK Conformity Assessed". The UKCA marking expresses the conformity of a product with all applicable legal requirements of the United Kingdom.</p>
	<p><b>Safe torque off</b> Corresponds to stop category 0 in accordance with EN 60204-1. The power supply to the drive is interrupted immediately and the drive is brought to an uncontrolled standstill</p>
	<p><b>GROUNDING</b> Chassis grounding (description in chapter 3.7.4 Electrical grounding (Chassis))</p>

## 2. Device description

### 2.1. Features

The PSx3xx positioning system, an intelligent, compact, complete solution for positioning auxiliary and positioning axes, consists of an EC motor, gear power amplifier, control electronics, absolute measuring system and DeviceNet interface. The integrated absolute measuring system eliminates the need for a time-consuming reference run. Connecting to a bus system simplifies the wiring. A hollow shaft with adjustable collar makes assembly quite simple. The positioning system is especially suitable for automatically setting tools, stops or spindles for wood-processing equipment, packing lines, printing equipment, filling units and other types of special machines.

PSx3xx positioning systems convert a digital positioning signal into an angle of rotation.

## 3. Installation

### 3.1. Electrical connection

#### NOTICE

The following notes on the power supply should be observed.

Minimum cross-sections are required for connection to the power supply. For power cables mounted on the device, use only the cross-sections listed below. In order to minimize voltage drop on longer cables, we always recommend using the largest available cross-section.

Device	Cable cross-section
PSEx31 / PSx32 / PSx33	min. AWG20 or 0,5 mm <sup>2</sup>
PSEx34	min. AWG18 or 1,0 mm <sup>2</sup>
Fieldbus connections	min. AWG23 or 0,25 mm <sup>2</sup>

If there are concerns about mechanical strength or where cables may be exposed to mechanical damage/stress, they must be protected accordingly. This can be ensured, for example, by a cable duct or a suitable armoured pipe.

If the power supply cables are laid in the immediate vicinity of the drives or other heat sources, make sure that the cables have a temperature resistance of at least 90°C. With suitable design measures, e.g. sufficient ventilation or cooling, lower temperatures are also permissible. This must be checked and determined by the customer.

Make sure that the flammability class of the cable for the USA is equivalent to UL 2556 VW-1, e.g. according to IEC 60332-1-2 or IEC 60332-2-2 depending on the cross-section. For Canada, the flammability class FT1 is required, FT4 exceeds this and is therefore also permissible. Cables for the North American market often meet both requirements.

However, the flammability class requirements only apply if you do not limit to Class 2 (e.g. certified power supply) or to <150 W according to UL 61010-1  
→ 3.6 Powering the device by means of a suitable fuse.

When installing in North America, please observe the specifications in the National Electrical Code NFPA 70 and the Electrical Standard for Industrial Machinery NFPA 79 (USA) or the Canadian Electrical Code and C22.2 (Canada) in the respective valid version.

Note the limitations of liability → 1.5 Limitation of liability.

### 3.2. Assembly of the positioning system



#### CAUTION

The maximum permissible axial and radial forces (see chapter 6.3 Physical data) on the motor shaft must not be exceeded during transportation, installation or operation.



#### CAUTION

Take the weight of the device into account when selecting the fastening screws! Tightening torques of the fixing screws according to the screw manufacturer's specifications!



#### WARNING

Rotating and/or linearly moving components can cause serious injuries. If there is a risk of accidents during installation or operation, the moving parts must be fitted with guards or protective devices.

#### NOTICE

##### Temperature overload

The PSx3xx positioning unit has a simple temperature measuring device to prevent thermal overload. If the temperature in the device exceeds the limit temperature set in the parameterization, this bit is set and repositioning is only possible after the device has cooled down ('Temperature exceeded' bit reset).

#### 3.2.1. Hollow shaft

The PSx3xx is mounted on the machine by sliding it with the hollow shaft onto the spindle to be driven and fixing it with the clamping ring (recommended shaft diameter 8 h9 or 14 h9; tightening torque of the clamping ring screw with 3 mm hexagon socket: 1.5 Nm).



#### CAUTION

The depth of the hollow bore is 20 mm. For optimum operation, the pin of the shaft to be driven should correspond to this depth. Depending on the operating situation, significantly shorter pins (< 16 mm) may cause damage to the PSx3xx. When mounting the PSx3xx, it should only be pushed on until the foam rubber plate lies evenly on the bottom of the machine or is compressed to approx. half its thickness. Under no circumstances may the PSx3xx "hard" be screwed to the machine without an air gap.

The rotation lock is made via the pin (in the picture below the hollow shaft) into a suitable bore as rotary torque support. This hole must be slightly larger than the diameter 6 h9 of the pin. An oblong hole or slot with a slightly larger width (recommended: 6.05...6.10 mm) than the dimension of the pin diameter is optimal.

The backlash when changing the direction of rotation has a direct influence on the positioning accuracy and can lead to damage to the PSx3xx with very large backlash (a few mm) due to the impact load



### CAUTION

The PSx3xx must have a little gap on all sides when mounted, as it can move axially and/or radially during positioning if the hollow shaft and solid shaft are not 100% aligned. This "staggering" is not a defect of the PSx3xx and also has no influence on the function, as long as it can move freely. Please note the maximum permissible radial force and axial force in chapter → 6.3 Physical data.

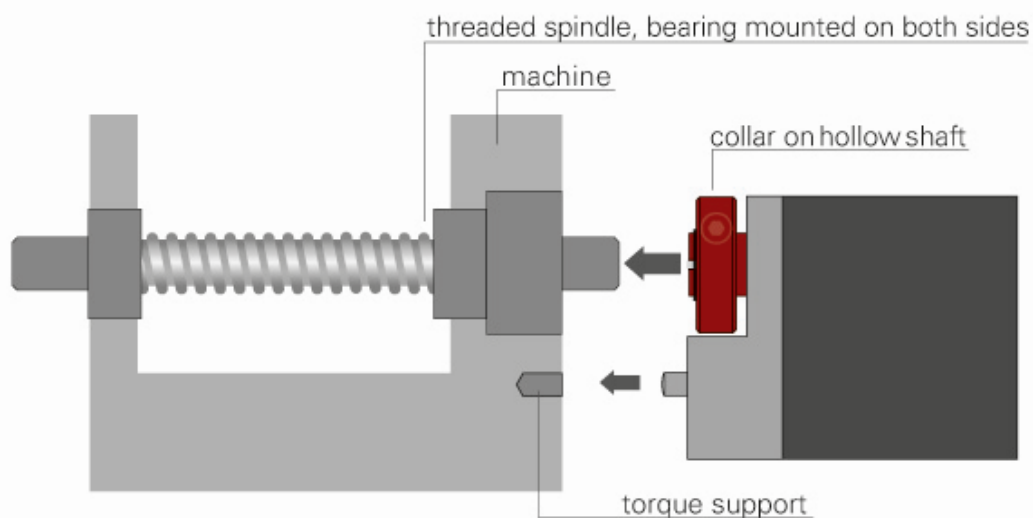

### Versions with higher torques (from 10 Nm):

Here the force connection is made via a feather key DIN 6885-A5x5x12.

The clamping ring is not freely rotatable but consists of two halves, the fixed part of the hollow shaft and the loose clamping clamp. The keyway is located in the half that is fixed to the output shaft. When sliding onto the shaft to be driven with the key inserted, its angular position must be aligned with the keyway in the PSx3xx. After pushing on, the PSx3xx is fixed with the 2 screws in the flexible clamping ring half. Make sure that both screws are tightened as equally as possible (tightening torque of the screws with 3 mm hexagon socket: 1.5 Nm).

The information on torque support applies in the same way as described above.

For PSE30x-14, PSE32x-14, PSS30x-14 and PSS32x-14, the position of the anti-rotation lock can be set at greater distances by unscrewing the base cover, turning it 180° and then screwing it back on. When screwing on, make sure that the seal is correctly inserted in the floor.

For torques > 5 Nm we recommend to choose the greater distance.

### 3.2.2. Solid shaft

The PSx3xx is installed on the machine by mounting the drive to the axis to be driven using a coupling and an intermediate flange.

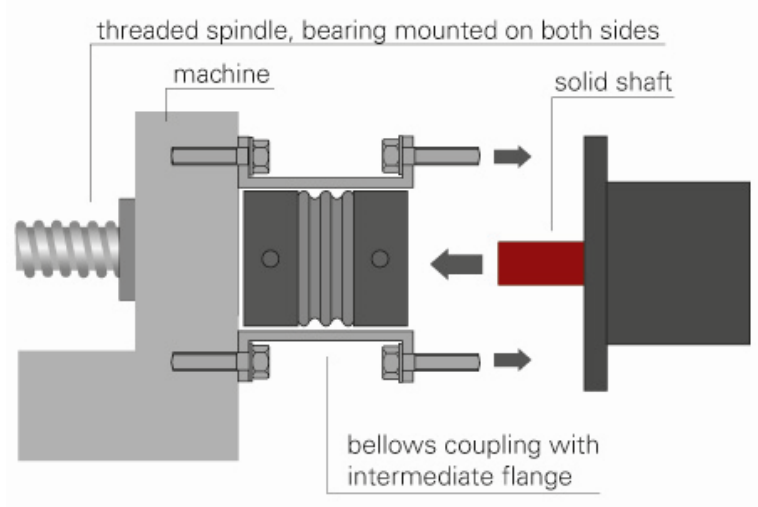

#### **⚠ CAUTION**

Under no circumstances may the housing cover be used for the purpose of the transmission of force.

#### **⚠ CAUTION**

Never apply force to the housing cover, e.g., for supporting weight.

#### **⚠ CAUTION**

Driving the PSx3xx rearward is prohibited (e.g. it's not allowed to turn the output shaft by an external force).

### 3.3. Disassembly

To remove the PSx3xx from the shaft, release the clamp (for versions with hollow shaft the clamping ring) and pull the PSx3xx off the shaft. If possible, the PSx3xx should only be pulled axially. Excessive bending back and forth can damage the output shaft!

For versions with brake, it is essential to observe the instructions in sections 5.12 Devices with optional holding brake and 5.13 Devices with optional friction brake!

### 3.4. Powering the device



#### CAUTION

For motor power use a single fuse with max. 3,5 A for each PSx3xx.  
 For motor power use a single fuse with max. 10 A for each PSE34xx.  
 For control power you can use a fuse with max. 2,0 A, so it is possible to power up to 10 units parallel with one fuse.  
 It is strongly recommended to separate power cables to the PSx3xx from other power cables that might have dangerous voltage.



#### CAUTION

Underwater usage of the PSW is not allowed.



#### CAUTION



Please consider that the device might have a hot surface during operation!



### 3.5. Pin assignment

For the supply voltage either a Binder series 715 (B-coded) round, 5-pin plug for PSE and PSS devices or a 5-pin Harting plug with protective sleeve (HAN4A) for the PSE34xx devices is located in the housing cover of the PSx3xxDN.

A series 713 (A coded) 5-pin round socket and 5-pin plug are provided for connecting the CAN bus.

A Binder series 718 4-pin plug is used to connect the jog keys (optional).

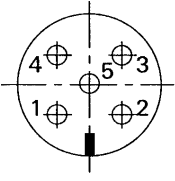
#### 3.5.1. Supply voltage connector (24VDC):

connector pattern (external top view)	assignment	type/producer
	<ol style="list-style-type: none"> <li>1. +24V motor</li> <li>2. GND motor</li> <li>3. not assigned</li> <li>4. not assigned</li> <li>5. housing/air drill</li> </ol>	PSE/PSS: series 713/763 (A-cod.); 5-pol.; Binder PSW: series 713/763 (A-cod.); 4-pol. with airtube; Binder
	<ol style="list-style-type: none"> <li>1. +24V motor</li> <li>2. GND motor</li> <li>3. not assigned</li> <li>4. not assigned</li> <li>5. housing/air drill</li> </ol>	PSE34xx: HAN4A, Harting

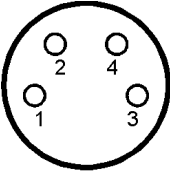

### 3.5.2. Connector for jog keys:

connector pattern (external top view)	assignment	type/producer
	<ol style="list-style-type: none"> <li>1. +24V (output)</li> <li>2. forward key</li> <li>3. reverse key</li> <li>4. ground</li> </ol>	M8; 4-pol.

### 3.5.3. Round plug and socket for CAN bus:

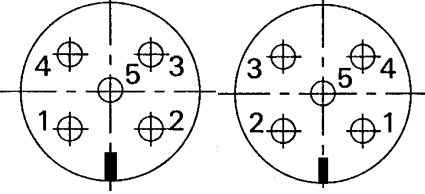
connector pattern (external top view)	assignment	type
<p style="text-align: center;">plug                      socket</p> 	<ol style="list-style-type: none"> <li>1. shield</li> <li>2. +24V control module</li> <li>3. GND</li> <li>4. CAN_H</li> <li>5. CAN_L</li> </ol>	M12 (B-cod.); 5-pol.

#### NOTICE

To prevent the ingress of fluids into the PSW-housing during cooldown, use a special cable with an airtube for pressure balancing of your PSW.

### 3.5.4. Electrical grounding (Chassis)

Next to the connecting plugs there is a M4 stud bolt. It is recommended to connect the positioning system with a cable as short as possible to the machine base. The minimum wire cross section therefor is 1.5mm<sup>2</sup>.

### 3.6. Setting the device address and baud rate

Removing the protective cap provides access to two rotary switches for setting the device address at the bus and a 2-pin sliding switch for setting the baud rate.

The rotary switches indicate the tens and ones places of the address selected. If the switches are resting in positions between 64 and 99, the address is set using DeviceNet (PSE object; class 100, instance 1, attribute 38; starting from software version 147).

The delivery setting is 99, the PSx3xxDN reports to the bus with the address 63.

If the switches have been used to set the address (i.e. the switch setting is < 64), this value cannot be changed via DeviceNet.

The yellow LED represents the state of the motor supply voltage, the red and green LEDs represent the DeviceNet state.

Switch configurations:

PSx30xDN, PSx31xDN-8, PSx31xDN-14, PSx33xDN  
PSx32xDN, PSE31xxDN

PSE 34xxDN

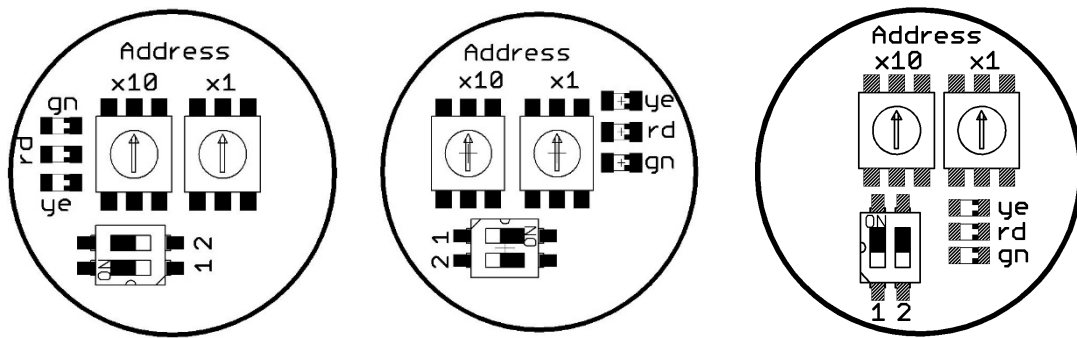

Setting the baud rate:

Up to firmware version 210:

1	2	PSx30xDN, PSx31xDN-8, PSx32xDN, PSx31xxDN,	PSx31xDN-14, PSx33xDN, PSx34xxDN,
OFF	OFF	125 kBaud	
OFF	ON	500 kBaud	250 kBaud
ON	OFF	250 kBaud	500 kBaud
ON	ON	baud rate is set via bus (default = 125 kBaud)	

For firmware version 211 and higher

1	2	PSx30xDN, PSx31xDN, PSx31xxDN, PSx32xDN, PSx33xDN	PSx34xxDN,
OFF	OFF	125 kBaud	
OFF	ON	500 kBaud	250 kBaud
ON	OFF	250 kBaud	500 kBaud
ON	ON	baud rate is set via bus (default = 125 kBaud)	

#### NOTICE

If the device names are given **without** the diameter of the output shaft (-8, -14), the relevant information is valid for **all** offered output shafts (applies throughout the document).

'x' in the device name stands for a number in the range 0..9. 'xx' in the device name stands for a number in the range 10..999.



#### CAUTION

Important: Always replace the protective cap after setting the address. This will prevent dust and contaminants from entering the instrument.

#### NOTICE

In some stainless steel variants, the protective cap is not present. In this case, device address and baud rate can only be set via bus.

### 3.7. Start-up

#### Positioning sequence (with reference loop)

The PSx3xxDN distinguishes between the following steps of a positioning sequence (Presumption: the target position is always approached through forward motion):

1. New position value is larger than the current value: position approached directly.
2. New position value is smaller than the current value: the device reverses an additional 5/8 of one rotation and approaches the exact position after resuming forward motion.
3. New position value after reverse run without loop: the device always approaches the position by moving in forward direction; if necessary, it will first reverse by 5/8 of a rotation.

Once the target position has been reached, the device compares it to the internal absolute encoder status. If a discrepancy is detected, the device then sets the "error" bit (bit 9 in the status word).

#### Positioning sequence (without loop)

The "positioning without loop" mode is used primarily for moving the small distances involved in fine adjustments. In this case, each position is approached directly. This does NOT eliminate any play present in the spindle in question. The PSx3xxDN internal gear backlash does not play a role in this case, as position data are acquired directly at the output shaft.

#### NOTICE

Runs which involve specifically a block run (e.g. reference runs on block), may only be started with reduced torque (max. torque max. 10% of the nominal torque).

### 3.8. CAN Bus

A DeviceNet protocol corresponding to ODVA CIP Networks Library Volume One Edition 3.1 and Volume Three Edition 1.3 is the protocol used for the CAN bus interface:

- A group 2 server with UCMM support
- 2 explicit connections to the master
- 4 fixed mapping assemblies
- I/O messages via poll, bit strobe and change-of-state/cyclic
- Multicast poll is not supported
- Heartbeat, default = inactive
- DeviceNet LED that displays status as follows:

LED status	description
off:	either the device is switched off or no CAN bus is connected
green, steady:	CAN communication OK, device operational
green, flashing:	either no UCMM connection to the master or no learning run has been performed
red, flashing	relatively minor error, at least one I/O connection has timed out
red, steady:	major error, e.g., bus conflict with another station
red-green, flashing	communication error

### 3.9. Table of implemented attribute entries

The following attributes are part of the PSE object (class ID 100), 1st instance:

Description	Attr. No.	Function	Range of value	Backup	Delivery State	R/W
target value	1	target position to be achieved value in 1/100 mm (for default settings of numerator, Attr. 16 and denominator, Attr. 17)	$\pm 31$ bit	no	0	R/W
actual value	3	current actual position value in 1/100 mm (for default settings of numerator, Attr. 16 and denominator, Attr. 17) Writing onto this index number causes the current position to be "referenced" onto the transferred value	$\pm 31$ bit	no		R/W
reference value	4	correction factor for the target, actual and limit switch values	$\pm 31$ bit	yes	0	R/W
drag error	5	maximum drag error before the "drag error" bit is set. Value given in increments (at a resolution of 0.5 mm)	20...1000 16 bit	yes	40	R/W

Description	Attr. No.	Function	Range of value	Backup	Delivery State	R/W
positioning window	6	permissible difference between target and actual values for "position reached" bit The maximum value that can be set changes according to the same factor as the resolution	1...100 16 bit	yes	2	R/W
actual value assessment, numerator	16	These values can be used to set a desired user resolution to the drive.	1...10000 16 bit	yes	400	R/W
actual value assessment, denominator	17	For a numerator factor of 400, the denominator factor holds the spindle pitch per resolution e.g.: spindle pitch 1.5 mm with resolution 1/100 mm: numerator = 400, denominator = 150	1...10000 16 bit	yes	400	R/W
target rpm posi	18	value in 1/min maximum rpm to be used for positioning runs	see table 16 bit	yes	see table	R/W
target rpm hand	19	value in 1/min maximum rpm to be used for manual runs	see table 16 bit	yes	see table	R/W
maximum torque	20	Applies after completion of start phase (during start phase the value of Attr. 24 applies); value in cNm	see table 16 bit	yes	see table	R/W
upper limit	22	maximum permitted target position permissible values: (-252...+509)*spindle pitch + reference value	±31 bit	yes	101200	R/W
lower limit	23	minimum permissible target position permissible values: upper limit - 0...250*spindle pitch + reference value	±31 bit	yes	1200	R/W
maximum start-up torque	24	value in cNm	see table 16 bit	yes	see table	R/W
time period for start-up torque	25	value in msec	10...1000 16 bit	yes	200	R/W
rpm limit for aborting run	26	value in % of the target rpm (1/min)	30...90 16 bit	yes	60 (PSx3110 and PSx3125) 30 (all others)	R/W
time elapsed until speed falls below rpm limit for aborting run	27	value in msec	50...500 16 bit	yes	200	R/W

Description	Attr. No.	Function	Range of value	Backup	Delivery State	R/W
length of loop	31	minimum number of increments which the drive moves in a pre-defined direction when approaching a target position value in increments (value = 0 → no loop)	0.025...1 rotations or 0 32 bit	yes	250	R/W
maximum rpm, counter-clockwise	32	value in 1/min	see table 16 bit	yes	see table	R/W
maximum rpm, clockwise	33	value in 1/min	see table 16 bit	yes	see table	R/W
size of individual increment	34	number of increments when external keys pressed (or when activating a jog run bit) for a short-time	1...100 16 bit	yes	1	R/W
idle period for manual run	35	Span of time a manual run key must be pressed (or a jog run bit must be activated) in order to begin a manual run value in steps of 5 msec	20...2000 16 bit	yes	200	R/W
control word	36	<p><u>Bit 0</u>: manual run to larger values</p> <p><u>Bit 1</u>: manual run to smaller values</p> <p><u>Bit 2</u>: transfer target value (when transferring a target value with the help of the poll I/O connection, a positioning run is only started if this bit is set)</p> <p><u>Bit 3</u>: release for manual run in jog key mode: if this bit is not set, only single steps are possible in jog key mode</p> <p><u>Bit 4</u>: release: the axle will only run if this bit is set (exception is the jog key mode with the external keys or with bits 8/9)</p> <p><u>Bit 5</u>: release for jog key mode with the external keys: If the CAN bus is connected, the external keys are only active if this bit is set</p> <p><u>Bit 6</u>: run without loop</p> <p><u>Bit 7</u>: start initial reference loop</p> <p><u>Bit 8</u>: jog run to larger values</p> <p><u>Bit 9</u>: jog run to smaller values</p> <p><u>Bit 10</u>: release readjustment</p> <p><u>Bit 11</u>: execute braking-free-run</p> <p><u>Bit 12</u>: run with drag error correction</p> <p>All other bits must be set to 0!</p>	16 bit	no	0	R/W

Description	Attr. No.	Function	Range of value	Backup	Delivery State	R/W
status word	37	<p><u>Bit 0</u>: target position reached</p> <p><u>Bit 1</u>: drag error</p> <p><u>Bit 2</u>: reverse jog key active</p> <p><u>Bit 3</u>: forward jog key active</p> <p><u>Bit 4</u>: motor power present</p> <p><u>Bit 5</u>: positioning run aborted</p> <p><u>Bit 6</u>: drive is running</p> <p><u>Bit 7</u>: temperature exceeded</p> <p><u>Bit 8</u>: movement opposite loop direction</p> <p><u>Bit 9</u>: error</p> <p><u>Bit 10</u>: positioning error (block)</p> <p><u>Bit 11</u>: manual displacement</p> <p><u>Bit 12</u>: incorrect target value</p> <p><u>Bit 13</u>: motor power was missing</p> <p><u>Bit 14</u>: positive range limit</p> <p><u>Bit 15</u>: negative range limit</p>	0...FFFFh 16 bit	no		R
CAN address	38	<p>address of drive (if set by CAN bus)</p> <p>This value cannot be changed if the address switches are used (i.e. the switch setting is &lt; 64). This attribute exists for software versions starting from version 147.</p>	0...63 8 bit	yes	63	R/W
baud rate	39	<p>0: 125 kBaud      1: 250 kBaud</p> <p>2: 500 kBaud</p> <p>This value cannot be changed if the baud rate switch is used (i.e. the switch setting is not ON-ON). This attribute exists for software versions starting from version 147.</p>	0...2 8 bit	yes	0	R/W
upper mapping end	40	<p>definition of the positioning range relative to the absolute measuring system</p> <p>permissible values: (1 + ref.value) ... (204800 * denominator / numerator - 1 + ref.value)</p>	±31 bit	yes	102400	R/W
holding torque	43	maximum holding torque at standstill in cNm	see table 16 bit	yes	see table	R/W
direction of rotation	44	<p>0: clockwise (as seen at the output shaft)</p> <p>1: counter clockwise</p>	0 or 1 16 bit	yes	0	R/W
running direction for approaching target positions	45	<p>0: with 5/8 forward rotation</p> <p>1: with 5/8 reverse rotation (5/8 rotation is the default value, see attr. 31)</p>	0 or 1 16 bit	yes	0	R/W
idle period	46	idle period in msec when reversing the direction of rotation	10...10000 16 bit	yes	10	R/W

Description	Attr. No.	Function	Range of value	Backup	Delivery State	R/W
actual rpm	48	value in 1/min	16 bit	no		R
maximum torque	49	maximum torque occurring during the most recent run (start phase, during which the maximum start-up torque applies, see attr. 24/25, and the phase when the drive is braking down, are not considered) value in cNm	16 bit	no		R
actual torque	51	value in cNm	16 bit	no		R
U control	58	current supply voltage for control unit given in increments of 0.1 V	16 bit	no		R
U motor	59	current supply voltage for motor given in increments of 0.1 V	16 bit	no		R
U <sub>mot</sub> limit	60	voltage limit for bit 'motor power present' given in increments of 0.1 V	180...240 16 bit	yes	185	R/W
U <sub>mot</sub> filter	61	average time for measuring current power to motor; given in 5 msec increments	100...100 16 bit	yes	100	R
temperature limit	62	upper temperature limit in °C	10...70 16 bit	yes	70	R
device temperature	63	internal device temperature in °C	16 bit	no		R
production date	64	year and week of manufacturing (given as an integer)	YYWW 16 bit	yes		R
serial number	65	serial device number	0...65535 16 bit	yes		R
waiting time for brake (end of run)	69	time period after the end of run, in which the brake stays released (value in msec)	0...3000 16 bit	yes	1000	R/W
version	78	software version number	16 bit	yes		R



Description	Attr. No.	Function	Range of value	Backup	Delivery State	R/W
delivery state	79	<p><u>writing '-1'</u>: generates the delivery state without modifying the CAN address and the baud rate (starts initial reference loop, then positioning to the middle of the measurement range)</p> <p><u>writing '-2'</u>: generates the delivery state (sets CAN address attr. 38 to 63, baud rate attr. 39 to 125 kBaud, starts initial reference loop, then positioning to the middle of the measurement range) A different CAN address or baud rate is only active after reset or reset communication!</p> <p><u>writing '1'</u>: saves all parameters in the EEPROM</p> <p><u>reading directly after boot</u>: 0 → content of memory correct ≠ 0 → content of memory incorrect</p> <p><u>reading after saving</u>: 0 → saving finished successfully ≠ 0 → saving is still in progress or is finished incorrectly (the time for saving is up to 100 msec)</p>	-1, -2 or 1 16 bit	no		R/W
control word, bit 0	80	manual run to larger values	0,1 8 bit	no		R/W
control word, bit 1	81	manual run to smaller values	0,1 8 bit	no		R/W
control word, bit 2	82	transfer target value	0,1 8 bit	no		R/W
control word, bit 3	83	release for manual run in jog key mode	0,1 8 bit	no		R/W
control word, bit 4	84	release	0,1 8 bit	no		R/W
control word, bit 5	85	release for jog key mode with the external keys	0,1 8 bit	no		R/W
control word, bit 6	86	run without loop	0,1 8 bit	no		R/W
control word, bit 7	87	start initial reference loop	0,1 8 bit	no		R/W
control word, bit 8	88	jog run to larger values	0,1 8 bit	no		R/W
control word, bit 9	89	jog run to smaller values	0,1 8 bit	no		R/W
control word, bit 10	90	release readjustment	0,1 8 bit	no		R/W
control word, bit 11	91	execute braking-free-run	0,1 8 bit	no		R/W

Description	Attr. No.	Function	Range of value	Backup	Delivery State	R/W
control word, bit 12	92	run with drag error correction	0,1 8 bit	no		R/W
status word, bit 0	96	target position reached	0,1 8 bit	no		R
status word, bit 1	97	drag error	0,1 8 bit	no		R
status word, bit 2	98	reverse jog key active	0,1 8 bit	no		R
status word, bit 3	99	forward jog key active	0,1 8 bit	no		R
status word, bit 4	100	motor power present	0,1 8 bit	no		R
status word, bit 5	101	positioning run aborted	0,1 8 bit	no		R
status word, bit 6	102	drive is running	0,1 8 bit	no		R
status word, bit 7	103	temperature exceeded	0,1 8 bit	no		R
status word, bit 8	104	movement opposite loop direction	0,1 8 bit	no		R
status word, bit 9	105	error	0,1 8 bit	no		R
status word, bit 10	106	positioning error (block)	0,1 8 bit	no		R
status word, bit 11	107	manual displacement	0,1 8 bit	no		R
status word, bit 12	108	incorrect target value	0,1 8 bit	no		R
status word, bit 13	109	motor power was missing	0,1 8 bit	no		R
status word, bit 14	110	positive range limit	0,1 8 bit	no		R
status word, bit 15	111	negative range limit	0,1 8 bit	no		R
waiting time for brake (begin of run)	146	time period before the begin of run, in which the brake can be released without the motor is moving (value in msec)	0...2000 16 bit	yes	150	R/W
number of braking-free steps	147	number of steps for the braking-free-run	1...50 16 bit	yes	see table	R/W
maximum holding torque at end of run	153	value in cNm	see table 16 bit	yes	see table	R/W
duration of maximum holding torque at end of run	154	time period at end of run, in which the 'maximum holding torque at end of run' applies (value in msec)	0...1000 16 bit	yes	200	R/W
acceleration	155	value in 1/min per sec.	see table 16 bit	yes	see table	R/W

Description	Attr. No.	Function	Range of value	Backup	Delivery State	R/W
deceleration	156	value in 1/min per sec.	see table 16 bit	yes	see table	R/W
10 general purpose registers	157... 166	to archive any kind of data (e.g. the function of a drive within an installation)	16 bit	yes	0	R/W

**Table of rated speed and torque values for the various device models**

Device model PSE and PSS		301-x 311-x	302-x 312-x	305-x 315-8	322-14 332-14	325-14 335-14	328-14
Name	Attribute No.	Range of value Delivery State					
target rpm posi	18	15...230 230	10...150 150	3...70 70	20...200 170	10...100 85	5...45 45
target rpm hand	19	15...230 80	10...150 50	3...70 20	20...200 80	10...100 40	5...45 22
max. rpm, counter clockwise	32	15...230 230	10...150 150	3...70 70	20...200 170	10...100 85	5...45 45
max. rpm, clockwise	33	15...230 230	10...150 150	3...70 70	20...200 170	10...100 85	5...45 45
acceleration	155	97...600 600	50...400 400	23...130 130	97...525 525	50...260 260	22...100 100
deceleration	156	97...600 600	50...400 400	23...130 130	97...525 525	50...260 260	22...100 100
maximum torque	20	2...100 100	10...200 200	50...500 500	10...200 200	20...400 400	80...800 800
maximum start- up torque	24	2...125 125	10...250 250	50...600 600	10...250 250	20...500 500	80...960 960
max. holding torque	43	0...90 30	0...150 50	0...300 100	0...100 35	0...200 70	0...450 150
max. holding torque at end of run	153	0...180 60	0...300 100	0...600 200	0...200 70	0...400 140	0...900 300
number of braking-free steps	147	1...50 4	1...50 4	1...50 3	1...50 4	1...50 4	1...50 3

Device model PSW		301-x 311-x	302-x 312-x	305-x 315-8	322-14 332-14	325-14 335-14	328-14
Name	Attribute No.	Range of value Delivery State					
target rpm posi	18	15...180 180	10...125 125	3...60 60	20...150 125	10...80 60	5...35 35
target rpm hand	19	15...180 80	10...125 50	3...60 20	20...150 80	10...80 40	5...35 22
max. rpm, counter clockwise	32	15...180 180	10...125 125	3...60 60	20...150 125	10...80 60	5...35 35
max. rpm, clockwise	33	15...180 180	10...125 125	3...60 60	20...150 125	10...80 60	5...35 35
acceleration	155	97...600 600	50...400 400	23...130 130	97...525 525	50...260 260	22...100 100
deceleration	156	97...600 600	50...400 400	23...130 130	97...525 525	50...260 260	22...100 100
maximum torque	20	2...100 100	10...200 200	50...500 500	10...200 200	20...400 400	80...800 800
maximum start-up torque	24	2...125 125	10...250 250	50...600 600	10...250 250	20...500 500	80...960 960
max. holding torque	43	0...90 30	0...150 50	0...300 100	0...100 35	0...200 70	0...450 150
max. holding torque at end of run	153	0...180 60	0...300 100	0...600 200	0...200 70	0...400 140	0...900 300
number of braking- free steps	147	1...50 4	1...50 4	1...50 3	1...50 4	1...50 4	1...50 3

Device model PSE		3110-14	3125-14	3410-14
Name	Attribute No.	Range of value Delivery State		
target rpm posi	18	1...30 30	1...12 12	10...100 100
target rpm hand	19	1...30 12	1...12 5	10...100 40
max. rpm, counter clockwise	32	1...30 30	1...12 12	10...100 100
max. rpm, clockwise	33	1...30 30	1...12 12	10...100 100
acceleration	155	9...50 50	4...20 20	20...350 350
deceleration	156	9...50 50	4...20 20	20...350 350
maximum torque	20	100...1000 1000	250...2500 2500	100...1000 1000
maximum start-up torque	24	100...1200 1200	250...3000 3000	100...1200 1200
max. holding torque	43	0...600 200	0...1250 450	0...300 200
max. holding torque at end of run	153	0...1200 400	0...2500 900	0...600 400
number of braking-free steps	147	1...50 3	1...50 3	1...50 4

Device model PSE		3210-14 3310-14	3218-14	3325-14	3418-14
Name	Attribute No.	Range of value Delivery State			
target rpm posi	18	5...40 40	3...22 22	2...12 12	5...90 90
target rpm hand	19	5...40 20	3...22 10	2...12 6	5...90 30
max. rpm, counter clockwise	32	5...40 40	3...22 22	2...12 12	5...90 90
max. rpm, clockwise	33	5...40 40	3...22 22	2...12 12	5...90 90
acceleration	155	25...130 130	15...70 70	10...50 50	10...315 315
deceleration	156	25...130 130	15...70 70	10...50 50	10...315 315
maximum torque	20	100...1000 1000	200...1800 1800	300...2500 2500	100...1800 1800
maximum start-up torque	24	100...1200 1200	200...2000 2000	300...3000 2800	100...2000 2000
max. holding torque	43	0...500 200	0...900 300	0...1200 400	0...450 300
max. holding torque at end of run	153	0...1000 300	0...1800 600	0...2500 800	0...900 600
number of braking-free steps	147	1...50 4	1...50 4	1...50 4	1...50 4

### 3.10. UCMM connection

Because the PSxxxDN is UCMM capable, the only way to communicate with the device is through a UCMM-compliant connection.

The PSxxxDN only supports the 8/8 body format, which means that the UCMM request parameters are fixed as follows:

- Source MAC ID = address of the master
- Service code = 0x4B
- Requested message body format = 0
- Group select = 3
- Source message ID = 0

The PSxxxDN will then confirm the connection request, whereby the connection instance ID is 5 (provided this is the first time the device is establishing a UCMM connection).

A (random) message must now be sent to the device on a cyclical basis (the standard expected packet rate is 10 sec.) in order to keep the connection active. Otherwise, this value must be changed (a value of 0 deactivates the monitoring function).

Explicit messages may be sent to the device from now on, whereby the corresponding ID can be determined from the following parameters:

- Message ID = 0
- Source MAC ID = address of the master
- Message group = 3

Deactivating timeout monitoring for the UCMM connection, for instance, requires the following explicit message:

- Message ID = 0
- Destination MAC ID = slave address
- Service code = 0x10
- Class ID = 5
- Instance ID = 5
- Attribute ID = 9 (expected packet rate)
- Value = 0x0000 (16 bit)

### 3.11. Explicit connection

Explicit messages can be used to read and write the attributes from a).

Identifier:

- Message ID = 0
- Source MAC ID = address of the master
- Message group = 3

Content:

- Destination MAC ID = slave address
- Service code = 0x10 (write); 0x0E (read)
- Class ID = 100
- Instance ID = 1
- Attribute ID according to list a)
- Value (if written)

### 3.12. I/O connections

The PSx3xxDN supports the following types of I/O messages:

- Poll (class ID 5, instance 2)
- Bit strobe (class ID 5, instance 3)
- Change-of-state/cyclic (class ID 5, instance 4), with or without master acknowledge

Setting up an I/O connection first requires the use of an explicit connection to allocate the desired I/O connection; the corresponding identifiers are then reserved and the connection is set to "configuring" status. The next step is to set the expected packet rate, after which point the I/O connection will be in place.

The expected packet rate is always attribute 9 (for a given instance in class 5).



#### CAUTION

**WARNING:** Activating the change-of-state/cyclic connection may cause the CAN bus to be flooded with messages as soon as the EPR has been set. To prevent this from occurring, the inhibit time (class ID 5, instance 4, attribute 17), which indicates the minimum amount of time that must elapse before a change-of-state event actually triggers an I/O message, should be set prior to establishing this type of connection. Only then should the EPR be set.

### 3.13. Mapping I/O assemblies

The following 4 assemblies are permanently stored in the PSx3xxDN:

Assembly object (class ID 4), **instance 100**, attribute 3:

Bit	Byte	Meaning	Source
0-31	0-3	actual value	PSE object (class ID 100), instance 1, attr. 3
32-47	4-5	status word	PSE object (class ID 100), instance 1, attr. 37
48-63	6-7	actual rpm (in 1/min)	PSE object (class ID 100), instance 1, attr. 48

Assembly object (class ID 4), **instance 101**, attribute 3:

Bit	Byte	Meaning	Source
0-16	0-1	status word	PSE object (class ID 100), instance 1, attr. 37

Assembly object (class ID 4), **instance 103**, attribute 3:

Bit	Byte	Meaning	Source
0-31	0-3	target value	PSE object (class ID 100), instance 1, attr. 1
32-47	4-5	control word	PSE object (class ID 100), instance 1, attr. 36

Assembly object (class ID 4), **instance 104**, attribute 3:

Bit	Byte	Meaning	Source
0-7	0	control word, bit 4 (release)	PSE object (class ID 100), instance 1, attr. 36

These assemblies cannot be changed and no additional assemblies may be added.

### 3.14. Assigning mapping I/O assemblies to available I/O connections

The PSx3xxDN allows the user to change how mapping I/O assemblies are assigned to available I/O connections. The current settings for each type of I/O connection are recorded in the connection object (class ID 5), instance 0, attr. 100-104. The following provides possible settings and default values:

Name	Attr. No.	Function	Range of values	Back up?	Delivery state	R/W
select input_poll	100	assembly instance that the device uses when establishing a poll connection for sending messages to the master (i.e., for a poll response message)	100, 101 8 bit	no	100	R/W
select output_poll	101	assembly instance that the device uses when establishing a poll connection for receiving messages from the master (i.e., for a poll command message)	103 8 bit	no	103	R/W
select input_bit_strobe	102	assembly instance that the device uses when establishing a bit-strobe connection for sending messages to the master (i.e., for a bit-strobe response message)	101 8 bit	no	101	R/W
select output_bit_strobe	103	assembly instance that the device uses when establishing a bit-strobe connection for receiving messages from the master (i.e., for a bit-strobe command message)	104 8 bit	no	104	R/W
select input_COS	104	assembly instance that the device uses when establishing a change-of-state/cyclic connection for sending messages to the master	100, 101 8 bit	no	100	R/W

### 3.15. Identifiers used for available I/O connections

The identifiers used for available I/O connections can be determined from the predefined master/slave connection set:

Bits for identifier										Meaning		
10	9	8	7	6	5	4	3	2	1	0		
1	0	slave MAC ID					1	0	1			poll command message (master)
0	1	1	1	1	slave MAC ID							poll response message (slave)
1	0	master MAC ID					0	0	0			bit-strobe command message (master)
0	1	1	1	0	slave MAC ID							bit-strobe response message (slave)
0	1	1	0	1	slave MAC ID							change-of-state/cyclic message (slave)
1	0	slave MAC ID					0	1	0			change-of-state/cyclic acknowledge message (master)



### 3.16. Detailed description of status bits

- Bit 0:** target position reached  
This bit is set:
- when a transferred target position has been reached successfully
  - after running an initial reference loop, when the actual value corresponds to the previously transferred target value
  - after manual displacement while at standstill, if readjustment is activated and the absolute value of the difference of actual and target value is smaller or equal to the positioning window again.
- This bit is reset:
- after transferring a target position if the difference from the actual value is larger than the positioning window (PSE object; class 100, instance 1, attribute 6)
  - by a manual run
  - if an invalid target value has been transferred
  - if rotated manually when on standstill
- Bit 1:** drag error  
This bit is set:
- if, after the acceleration phase, the maximum speed setting has not been achieved
- This bit is reset:
- with each new run command
- Bit 2:** reverse jog key active  
This bit is set:
- if Pin 3 on the key connector is connected with Pin 1 (+24V)
- This bit is reset:
- if Pin 3 on the key connector is disconnected from Pin 1 (+24V)
- Bit 3:** forward jog key active  
This bit is set:
- if Pin 2 on the key connector is connected with Pin 1 (+24V)
- This bit is reset:
- if Pin 2 on the key connector is disconnected from Pin 1 (+24V)
- Bit 4:** motor power present  
This bit is set:
- if the supply voltage to the motor is above the U<sub>mot</sub> limit (PSE object; class 100, instance 1, attribute 60) and below 30V
- This bit is reset:
- if the supply voltage to the motor is below the U<sub>mot</sub> limit or above 30V
- Bit 5:** positioning run aborted  
This bit is set:
- if a positioning run is aborted because release in the control word has been withdrawn
- This bit is reset:
- when a new run command is transmitted

- Bit 6:** drive is running  
This bit is set:  
- when the drive is rotating  
This bit is reset:  
- when the drive is on standstill
- Bit 7:** temperature exceeded  
This bit is set:  
- if the internal device temperature device exceeds the limit value (PSE object; class 100, instance 1, attribute 62)  
This bit is reset:  
- if the internal device temperature falls below the limit value by 5°C
- Bit 8:** movement opposite loop direction  
This bit is set:  
- during a manual run in the direction opposite that of the loop direction (a subsequent manual run in the loop direction will not reset this bit)  
- during a positioning sequence in the direction opposite that of the loop direction  
This bit is reset:  
- when a transferred target position has been reached successfully (in the loop direction)  
- after the initial reference loop
- Bit 9:** error  
This bit is set:  
- if an internal problem is detected when calculating a position.  
No run commands (except the initial reference loop) can be executed when the error bit is set!  
This bit is reset:  
- when an initial reference loop is completed correctly
- Bit 10:** positioning error (block)  
This bit is set:  
- if a positioning run is aborted because the device is overloaded (block, extreme difficulty while running)  
This bit is reset:  
- by transmitting a new positioning command  
- after an initial reference loop has been executed correctly
- Bit 11:** manual displacement  
This bit is set:  
- if, while on standstill, the drive is turned externally by more than the value in the positioning window  
This bit is reset:  
- by transmitting a new positioning command  
- after an initial reference loop has been executed correctly

*Bit 12:* incorrect target value

This bit is set:

- when a transferred target value lies outside of the limit switches; also caused, for instance, because of the actual value of the referencing value (attr. 4)
- when a transferred target value lies inside of the limit switches; but because of a necessary loop run the specified interval would be left

This bit is reset:

- by transmitting a valid target value

*Bit 13:* motor power was missing

This bit is set:

- if the power to the motor lies below the U<sub>mot</sub> limit (PSE object; class 100, instance 1, attribute 60) or above 30V when initiating a positioning run or an initial reference loop
- if during the run the voltage leaves the given corridor

This bit is reset:

- if the power to the motor is above the U<sub>mot</sub> limit and below 30V when initiating a positioning run or an initial reference loop

*Bit 14 / 15:* positive / negative range limit

This bit is set:

- if the limit value is reached during a manual run (but not if reached during a positioning run)
- if a limit value is modified such that the current position lies beyond the limit
- if, while on standstill, by means of an external force the drive is moved to a position which is outside the area which is defined by the range limits

This bit is reset:

- by initiating a positioning run, an initial reference loop or a manual run

### 3.17. Detailed description of control bits

- Bit 0:* manual run to larger values
- Bit 1:* manual run to smaller values
- Bit 2:* transfer target value: When transferring a target value with the help of an I/O connection, positioning will only take place if this bit is set.
- Bit 3:* Release for manual run in jog key mode:  
This bit must be set in order to switch from jog key mode (run activated via the keys, if bit 5 is set; or via command if bit 8 or 9 is set in the control word, if bits 4 and 5 are not set) to manual run mode by holding down a key (or activating a jog run bit for a longer time). Single increments are the only option in jog key mode if this bit is reset.
- Bit 4:* Release: Run commands will only be executed if this bit is set (exception is the jog key mode with the external keys or with bits 8/9 of the control word). This bit must be set for positioning runs, manual runs and must not be set for jog runs.  
If this bit is cleared during a run, the run will be aborted and status bit 5 will be set ('positioning run aborted').
- Bit 5:* Release for jog key mode with the external keys: If the CAN bus is active, jog key mode via the external keys is only possible if this bit is set and bit 4 is reset. For jog key mode via CAN (bits 8 or 9 in the control word), this bit must not be set.
- Bit 6:* Run without loop: If this bit is set during positioning runs, all target positions will be approached directly (without loop).
- Bit 7:* Start initial reference loop: the device performs 5/8 of one rotation opposite to the loop direction; it will then perform 5/8 of a rotation in loop direction at manual run speed.  
In earlier versions, this command had to be executed after switching on the device; that is no longer the case.
- Bit 8:* Jog run to larger values: Comes up to a keystroke of forward key (bit 3 in the status word). Bits 4 and 5 must not be set in this mode!
- Bit 9:* Jog run to smaller values: Comes up to a keystroke of reverse key (bit 2 in the status word). Bits 4 and 5 must not be set in this mode!
- Bit 10:* Release readjustment: Only if this bit is set the drive readjusts when it is displaced out of its position in the direction opposite to that of the loop direction at the end of a run. If bit 6 („run without loop“) is being set, the drive readjusts the position in both directions.

- Bit 11:* Execute braking-free-run: At the beginning of a positioning at first the brake is released and the “waiting time for brake” is being awaited (attribute 146). Within this time the brake should move towards its working position (in this position of the brake the motor can move freely). After this waiting time the motor moves a certain distance in both directions, in order to release a brake which is eventually stucked. This distance (“number of braking-free steps”) is being set in attribute 147. For the execution of this command, bit 4 has to be set simultaneously.
- Bit 12:* Run with drag error correction: If the bit is set, the drive trys (under consideration of the configured maximum torque) to compensate a drag error which has been developed. By controlling the rpm on a value which is slightly above or below the configured ‘target rpm posi’ (attr. 18), the drag error decreases. The drag error correction operates only in positioning runs, i.e. not in manual runs or in jog key mode. Furthermore, it operates only while accelerating and cruising with constant rpm, not while decelerating. The time-dependent setting value for the rpm while accelerating arises out of the rpm at beginning of the positioning as well as the acceleration setting (attr. 155).
- Bit 13:* reserved, must be programmed to 0
- Bit 14:* reserved, must be programmed to 0
- Bit 15:* reserved, must be programmed to 0

### 3.18. Quick test for checking the drive and the DeviceNet interface

- Switch device off.
- Set device address to 63.
- Set baud-rate selector switch to 125 kBaud.
- Connect both plugs for the motor supply voltage and the CAN plug.
- Set the CAN receiver to 125 kBaud and activate.
- Switch the device on.
- The device will send 2 messages at an interval of precisely 1 sec. along with the duplicate MAC ID check message (ID 0x5FF). The message contains the serial number and production date.
- Establish the UCMM connection:  
781 3F 4B 00 30
- Set the expected packet rate to 0 within 10 sec.:  
601 3F 10 05 05 09 00 00
- Set the target value to 5000, fragment 1:  
601 BF 00 10 64 01 01 88 13
- Set the target value to 5000, fragment 2:  
601 BF 81 00 00
- Set the control word to 0x14:  
601 3F 10 64 01 24 14 00
- The drive will move to position 5000.
- Set the target value to 50000, fragment 1:  
601 BF 00 10 64 01 01 50 C3
- Set the target value to 50000, fragment 2:  
601 BF 81 00 00
- The drive will move to position 50000.

## 4. Sequence of positioning steps

In order to control the drive using I/O connections, you must first establish an explicit connection using the UCMM; this connection is then used to allocate and configure the desired I/O connection.

### - Transfer target value:

- Poll I/O message with control word 14h and target value, OR
  - If release has not been set in the control word: set target value explicitly (using the PSE object; class 100, instance 1, attribute 1); bit-strobe message, bit is set, OR
  - If release has been set in the control word: set explicit target value (using the PSE object; class 100, instance 1, attribute 1).
- Drive begins run.

### - Aborting a run by withdrawing release:

- Poll I/O with control word 0, OR
- Bit strobe; bit is reset, OR
- Control word set explicitly to 0
- If a new target value is transferred during a positioning run, the device will immediately proceed to the new target. This will occur with no interruption provided the direction of rotation does not need to be altered.
- If a manual run is transmitted during a positioning run, the positioning run will be aborted (speed will be reduced to that of a slow run) and the operator may proceed with the manual run.

### The following sequence of steps is also possible:

Starting condition:

- release has not been set
- Target value has already been transferred (in case of poll I/O transfer the release in the control word was not set already)

Set release: → drive begins run

#### 4.1. Positioning sequence with loop

By default, the PSx3xx always approaches each setpoint from the same direction. If a destination is in the opposite direction to the loop direction, the setpoint is first traversed by the value of the loop length (Par. 45) and then finally approached. This can, for example, eliminate the backlash of a driven spindle.

The PSx3xx thus distinguishes the following cases during a positioning process:  
Assumption: Each target position is approached in forward direction, i.e. the loop length is 250 steps = 5/8 revolutions.

1. New setpoint position is greater than the current actual position: The target is approached directly.

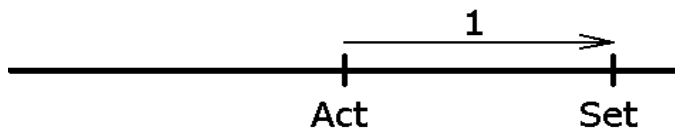

2. New setpoint position is smaller than the current actual position: The device is moved further back by the loop length (2a) and the final destination is then approached in forward motion (2b).

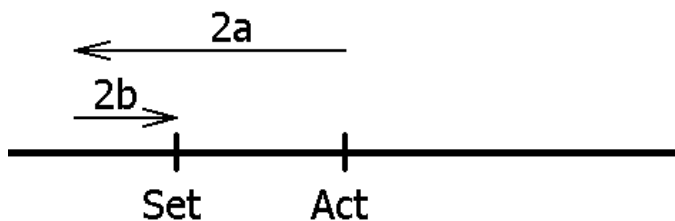

3. New setpoint position is only slightly larger than the current actual position and previously there was no positioning movement with loop (e.g. a manual movement):

In all cases, the drive approaches the target with a forward movement whose length corresponds at least to the loop length. In order to achieve this, the drive first moves in reverse direction (3a), i.e. against the actually desired direction of travel, and then forwards the actual destination (3b).

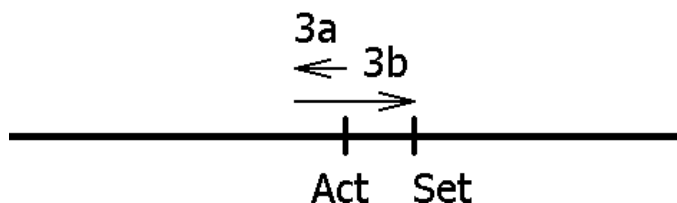

The maximum length of this distance is the loop length. If the setpoint differs from the current actual value by more than the loop length, it is approached directly.

After reaching the target position, this position is compared with the internal absolute encoder status. If there is a deviation, the status bit "Error" is set (bit 9 in the status word).

In the delivery state, the loop length is 250 steps, i.e. each setpoint position is approached in the forward direction.



## NOTICE

A positioning to the upper end limit (Par. 42) with a loop length  $> 0$  is not possible, since the drive would have to cross the end limit for this. The same applies to the lower end limit (Par. 43) with a loop length  $< 0$ .

### 4.2. Positioning run without a reference loop

The sequence corresponds to that of a positioning run with a loop; in addition to setting the release, however, bit 6 in the control word also has to be set to execute the run without loop.

### 4.3. Manual run

- Transfer manual run:
  - Poll I/O with control word 11h or 12h
  - OR
  - Set control word explicitly to 11h or 12h (using the PSE object; class 100, instance 1, attribute 36)
  - Drive begins run.
- End manual run by withdrawing manual run:
  - Poll I/O with control word 10h
  - OR
  - Set control word explicitly to 10h (using the PSE object; class 100, instance 1, attribute 36)
- End manual run by withdrawing release:
  - Poll I/O with control word 0h
  - OR
  - Bit strobe with bit 0
  - OR
  - Set control word explicitly to 0h (using the PSE object; class 100, instance 1, attribute 36)
- Transferring a target value during a manual run will end the run and the device will immediately move on to the transmitted position.

## 5. Special features

### 5.1. Speed, acceleration and deceleration

The initial reference loop and the manual run are performed at the maximum speed specified in the PSE object; class 100, instance 1, attribute 19; positioning runs are performed at the maximum speed specified in attr. 18. When the run is counterclockwise, additionally the maximum speed in attr. 32 applies, when the run is clockwise, the one in attr. 33 applies. For all runs the maximum acceleration of attr. 155 and the maximum deceleration of attr. 156 apply. At the end of each run, the maximum deceleration decreases during the approach to the destination successively in order to realize a harmonic transient behaviour.

### 5.2. Maximum starting torque and maximum torque

Via attr. 24 the maximum starting torque can be set, via attr. 20 the maximum driving torque.

The starting torque is active for the period in attr. 25 after each start of travel. It should always be slightly higher than the driving torque, since the drive requires more torque for the acceleration phase than for constant driving.

Both values are not sharp torque limits, instead the motor current is limited to a value which corresponds to the current consumption at the nominal speed at the set torque. If a lower speed than the rated speed is set, the achievable torque is slightly higher than at the (default) nominal speed.

#### NOTICE

If small torque limits are to be used, it must be considered not to use these in combination with high speed values, as this can lead to unstable driving behaviour!

### 5.3. Response of drive in case of block or manual displacement

If the achievable speed falls below the limit value of 30% of the selected maximum speed (attr. 26) for longer than 200 ms (attr. 27) (these are the default values), blocking is detected, the movement is aborted and the "Positioning error" bit is set. The drive is now stopped with the holding torque set..

New motion tasks can then be sent without further measures, i.e. the transmission of a new target position (change of the value of the target position in the process data) starts a new positioning.

An exception exists if the setpoint value is the same as before. In this case, the enable bit must first be removed and then set again (bit 4 in the control word). The drive then continues to run when the enable bit is set (either by Poll I/O or explicit).

#### NOTICE

Runs which specifically result in a block run (e.g. reference runs on a block) may only be started with a reduced torque (max. running torque max. 10% of the nominal torque or smallest possible value).

#### 5.4. Behaviour of the actuator during manual rotation (readjustment function)

If the PSx3xx is turned against the loop direction at standstill after a correctly completed positioning movement (or manual movement to the end of the movement range) and the enable bit (bit 4 in the control word) as well as the follow-up control bit (bit 10) are activated, the PSx3xx attempts to approach the previously transmitted setpoint again (readjustment). When turning in loop direction, no readjustment takes place, only bit 11 in the status word ("Manual turning") is set and bit 0 ("Target position reached") is reset. If bit 6 in the control word ("movement without loop") is set, the drive adjusts in both directions.

#### NOTICE

If the drive continuously loses its position at standstill, an attempt is made to readjust it exactly when the actual position is just leaving the positioning window (provided that all the above conditions are fulfilled). At this point, the motor voltage must be within the permissible range (i.e. bit 4 set in the status word). If the motor voltage is incorrect, no readjustment starts, instead bits 10 ("positioning error") and 13 ("motor voltage was missing") become active. If the motor voltage does not return to the allowed range until after leaving the positioning window, no new readjustment attempt is started. This prevents a situation where a drive suddenly starts a movement when the motor voltage is switched on.

If a current positioning or manual movement is aborted by a stop command (enable bit in the control word set to 0), the drive does not readjust until a new movement request has been sent and correctly terminated.

The readjustment can be completely prevented by removing the enable bit and/or the readjustment function.

Actuators with brake have no readjustment function in general..

#### 5.5. Calculating the absolute physical position

The PSx3xxDN actuator includes an absolute measuring system with measurement range of 250 rotations. This allows the user to determine the direction of rotation for any desired portion of these 250 rotations.

The mapping of the desired positioning range to the physical positioning range is done with the help of the parameter 'upper mapping end' (atr. 40).

In the delivery state, the drive is at position 51200, the upper limit switch is set to 101200 and the lower limit switch is set to 1200, yielding a positioning range of  $\pm 125$  rotations ( $\pm 50000$  increments). So if the desired positioning range doesn't exceed  $\pm 125$  rotations, in delivery state none of the following actions to adjust the positioning range have to be taken.

For the realization of any desired positioning range independent of the possible positioning range which is defined by the mounting situation (physical positioning range) there are the following two possibilities:

- 1) Move the axle (for example a spindle) to the desired position, then move the drive (with opened collar) to the position value which belongs to the physical position of the axle, only then close the collar.

Examples:

- a) Move the axle in middle position, then move the drive at no-load (with opened collar) also to middle position (position 51200), then close the collar. The drive is now capable of moving 125 rotations ( $\pm 50000$  increments by default) in each direction.
  - b) Move the axle completely to the left (resp. bottom), then move the drive at no-load (with opened collar) without loop to the lowest position (position 1200), then close the collar. The drive is now capable of moving 250 rotations ( $\pm 100000$  increments by default) to the right (resp. top).
  - c) Move the axle completely to the right (resp. top), then move the drive at no-load (with opened collar) to the highest position (position 101200), then close the collar. The drive is now capable of moving 250 rotations ( $\pm 100000$  increments by default) to the left (resp. bottom).
- 2) Mount the drive in any position on the axle, close the collar, then adjust the positioning range with the help of attr. 40. Attr. 40 defines the upper end of the positioning range. By default, the upper end is at +256 rotations (position 102400). If the positioning range doesn't suit to the actual displayed position after mounting the drive, the upper end of the positioning range can be adjusted between -256 rotations and +512 rotations.

Examples:

- a) After mounting the drive, the displayed position is 51200 (which corresponds the delivery state). But the positioning range shall solely spread to the right (resp. top) → Set attr. 40 to 152400.
- b) After mounting the drive, the displayed position is 100000. But the positioning range shall solely spread to the right (resp. top) → Set attr. 40 to 201200.
- c) After mounting the drive, the displayed position is 2000. But the positioning range shall solely spread to the left (resp. bottom) → Set attr. 40 to 3200.

Remarks:

- 1) When calculating the upper mapping end (attr. 40), a security reserve of 3 rotations has to be kept in mind (1200 increments by default, see the examples above), because the highest possible position value is 3 rotations below the upper mapping end. The lowest possible position value is 253 rotations below the upper mapping end.
- 2) The above given increment and position values relate to the following settings, which correspond to the delivery state:
  - a) referencing value (attr. 4) = 0
  - b) actual value assessment, numerator (attr. 16) = 400
  - c) actual value assessment, denominator (attr. 17) = 400
 These 3 attributes have an influence on the above given increment and position values: With the help of the referencing value a shift can be reached, with the help of the actual value assessment numerator and denominator a stretching or distension can be reached (see below).
- 3) When changing the direction of rotation (attr. 44), the referencing value (attr. 4), the upper mapping end (attr. 40) and the upper and lower limit (attr. 22 and 23) are set to delivery state.
- 4) When changing the upper mapping end (attr. 40), the upper and lower limit (attr. 22 and 23) are set to delivery state.
- 5) When changing the actual value assessment numerator or denominator (attr. 16 or 17), the target value, the actual value, the referencing value, the upper mapping end, the upper and lower limit, the positioning window and the length of loop are re-calculated.
- 6) When changing the referencing value (attr. 4), the target value, the actual value, the upper mapping end and the upper and lower limit are re-calculated. If the values of the upper mapping end (Attr. 40) and/or the limit switches (Attr. 22 and 23) are sent as standard with each upper move of the device, the new referencing value may have to be included in these values. This can be done, for

example, by defining base values (which apply in the case of "referencing value = 0"), to which the respective current value of the referencing value is then added.

- 7) If the user wants to go over any automatic re-calculation of values when setting up the device, the optimum order of transferring the parameter is the following:
  - a) direction of rotation (attr. 44),  
actual value assessment, numerator (attr. 16),  
actual value assessment, denominator (attr. 17)
  - b) referencing value (attr. 4)
  - c) upper mapping end (attr. 40)
  - d) upper limit (attr. 22),  
lower limit (attr. 23),  
positioning window (attr. 6),  
length of loop (attr. 31)
- 8) In order to save the settings permanently in the EEPROM, write 1 to attr. 79. As soon as reading of attr. 79 shows 0, the saving is finished.

#### Referencing value (attr. 4):

The referencing process affects all transferred values, i.e., the target value, actual value, upper mapping end and upper and lower limit.

There are two ways of setting the referencing value:

- 1) Directly, by writing the referencing value to attr. 4.
- 2) Indirectly, by writing an actual value to attr. 3. This makes it possible to assign any "true" actual value to the current, physical actual value. The resulting difference is then the referencing value. This value will immediately be included in calculations for each transferred value and can also be read via attr. 4.

When changing the referencing value, automatically the target value, the actual value, the upper mapping end and the upper and lower limit are re-calculated.

#### NOTICE

The removal of the **motor** power supply has no affect on the internal measuring system.

### 5.6. Use of the “Upper mapping end” parameter

The following chapter illustrates the use of the parameter “upper mapping end” both graphically and by means of examples:

#### 5.6.1. Delivery state

In the delivery state (“DS”), the actual position is exactly in the middle of the positioning range. There is a safety margin of three rotations at the output shaft at both the lower and upper ends of the positioning range. Positioning runs that extend into these safety margins are rejected by the device with the error “Incorrect target value”.

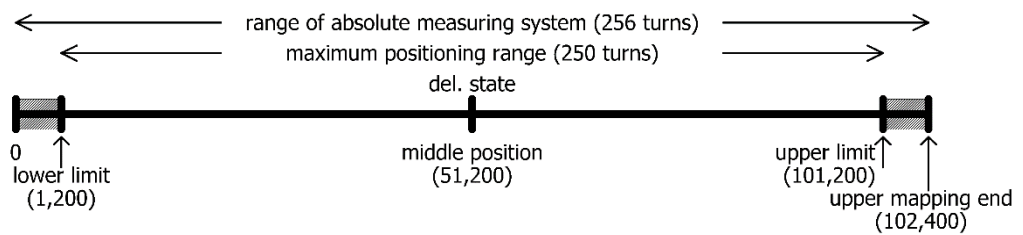

In the delivery state, the values from the following table result for the upper mapping end and the lower and upper limits:

Upper mapping end	102,400
Lower limit	1,200
Upper limit	101,200

Positioning range **symmetrical** to 51,200

Starting from this state, the maximum possible positioning range can now be shifted upwards or downwards as required.

It is important to note that after the device has been installed, the available positioning range may not be sufficient in one of the two directions. The parameter “upper mapping end” now allows you to reduce the positioning range in one direction and increase it in the other direction.

#### 5.6.2. Shifting the positioning range upwards starting from the delivery state

In the following example, starting from the DS, the maximum possible positioning range is shifted slightly **upwards** using the parameter “upper mapping end”:

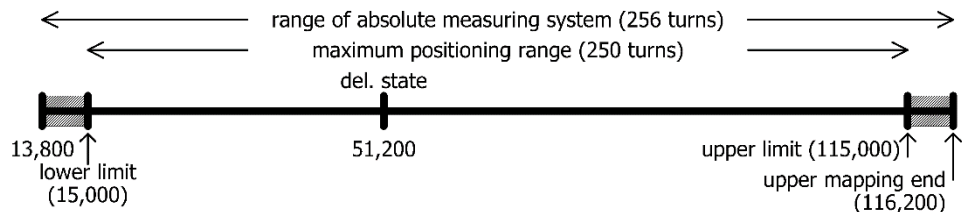

Here, the upper mapping end was increased from the value 102,400 to 116,200. Consequently, a higher proportion of the possible positioning range is above 51,200 and a smaller proportion below 51,200.

A special case is present if the upper mapping end is set so that the entire possible positioning range is at values  $\geq 51,200$ . With standard scaling (numerator =

denominator = 400, i.e. 1 step = 0.9°) and referencing value = 0, this special case results if the relevant value from the following table is selected for the upper mapping end. The device then automatically adjusts the lower and upper limits accordingly.

Upper mapping end	152,400
Lower limit	51,200
Upper limit	151,200

Positioning range **starts** at 51,200

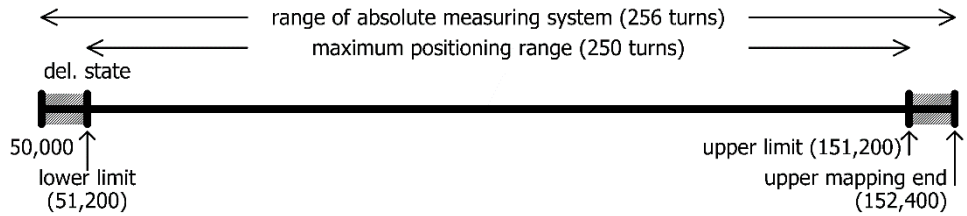

**NOTICE**

The numerator factor and denominator factor can be used to map any spindle resolutions. Using the referencing value, you can shift the whole range of values.

**5.6.3. Shifting the positioning range downwards starting from the delivery state**

In the following example, starting from the DS, the maximum possible positioning range is shifted slightly downwards using the parameter “upper mapping end”:

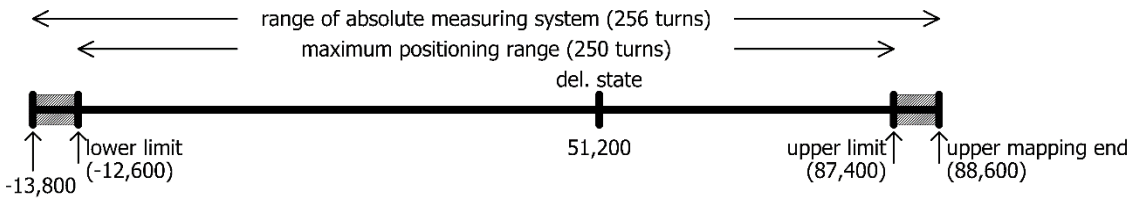

Here, the upper mapping end was decreased from the value 102,400 to 88,600. Consequently, a higher proportion of the possible positioning range is below 51,200 and a smaller proportion above 51,200.

A special case is present if the upper mapping end is set so that the entire possible positioning range is at values  $\leq 51,200$ . With standard scaling (numerator = denominator = 400, i.e. 1 step = 0.9°) and referencing value = 0, this special case results if the relevant value from the following table is selected for the upper mapping end. The device then automatically adjusts the lower and upper limits accordingly.

Upper mapping end	52,400
Lower limit	-48,800
Upper limit	51,200

Positioning range **ends** at 51,200

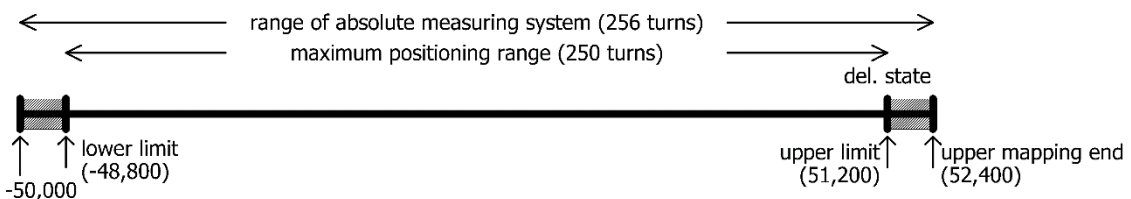

#### 5.6.4. Shifting the positioning range depending on the actual position

Are (in contrast to the examples above) one or more of the parameters “numerator”, “denominator” and “referencing value” not in the delivery state, these are included in the calculation of the possible value range for the upper mapping end.

Please note that the measurement range of the absolute encoder is 256 rotations at the output shaft.

Starting from the delivery state, the possible positioning range may now be shifted

- by max. 256 rotations upwards
- by max. 256 rotations downwards

On the basis of these considerations the following value range results for the upper mapping end:

$$\begin{aligned} \text{Minimum value for upper mapping end} &= \text{referencing value} + 1 \\ \text{Maximum value for upper mapping end} &= \text{referencing value} + 204,800 * \text{denom.} / \\ &\quad \text{num.} - 1 \end{aligned}$$

The following formulas result for the special case numerator = denominator:

$$\begin{aligned} \text{Minimum value for upper mapping end} &= \text{referencing value} + 1 \\ \text{Maximum value for upper mapping end} &= \text{referencing value} + 204,799 \end{aligned}$$

(This is the case, e.g. for the delivery state where numerator = denominator = 400.)

#### NOTICE

Since the upper mapping end is an integer, the minimum and maximum values are obtained by rounding to the nearest integer (applies only to the case numerator  $\neq$  denominator).

#### NOTICE

If the actual position is no longer in the area  
*[upper mapping end - 256 rotations ... upper mapping end]*  
 after shifting the upper mapping end, the device then automatically adjusts the actual position accordingly. This is done by addition or subtraction of the number of steps which corresponds to 256 rotations. For the special case numerator = denominator this would be 102,400 steps.



Example:

- Spindle with 5 mm pitch, specified unit for target and actual values: 1µm  
 → 1 rotation = 5mm = 5,000µm  
 → Number of steps per rotation = 5,000
- Using the formula  

$$\text{Number of steps per rotation} = 400 * \text{denominator} / \text{numerator}$$
 the following result is obtained:  
 numerator = 400; denominator = 5,000
- With these settings, the drive is mounted and run using manual positioning commands, to a defined physical position (e.g. a specific mark along the run path) at which the actual position is to assume a specific value, e.g. the value 0.
- In our case, the position after running to this defined physical position shows, for example, the value 300,000. In this position, the actual value is set to zero. The device uses this information to calculate the new referencing value at 300,000.  
 → Referencing value = 300,000
- The drive has a positioning range of 250 rotations (see above: Measurement range of the absolute encoder minus a safety margin of three rotations at both ends of the measurement range).
- In our case, these 250 rotations are to be divided in such a way that the drive can run 10 rotations (= 10 \* 5,000 steps = 50,000 steps) from the zero position, just defined, to smaller values and 240 rotations (= 240 \* 5,000 steps = 1,200,000 steps) to larger values.
- To ensure that the position value 1,200,000 is at the upper end of the maximum possible positioning range, as specified (i.e. at the upper limit), we add the safety margin of three rotations to this value and thus obtain our value for the upper mapping end:  

$$\text{upper mapping end} = 1,200,000 + 3 * 5,000 = 1,215,000$$
- The device then recalculates the positioning range limits:  

$$\text{lower limit} = \text{upper mapping end} - 253 * 5,000 = -50,000$$

$$\text{upper limit} = \text{upper mapping end} - 3 * 5,000 = 1,200,000$$
- This positioning range can then be restricted as required, i.e. the lower limit can be increased and the upper limit can be reduced.

### 5.6.5. Step-by-step instructions for determining the positioning range

The following section describes the procedure for determining those parameters that have an influence on the target and actual position as well as the positioning range. The individual steps must be carried out in the specified order.

1) Setting the direction of rotation:

The direction of rotation determines with which direction of rotation of the output shaft the position values increase and with which direction of rotation of the output shaft the position values decrease.

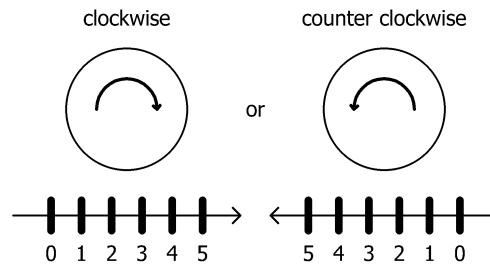

2) Setting numerator and denominator:

The numerator and denominator determine the number of steps into which one rotation of the output shaft is divided.

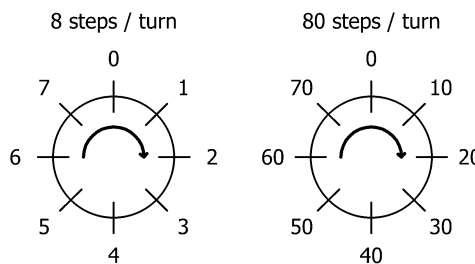

3) Setting referencing value:

The referencing value is used to assign a specific value of the actual position to a specific physical position of the axle.

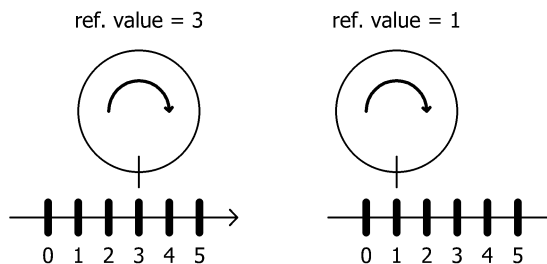

The referencing value is written either directly or by setting the actual position.

4) Setting upper mapping end:

The parameter defines the location of the maximum possible positioning range, taking into account the scaling values and the referencing value.

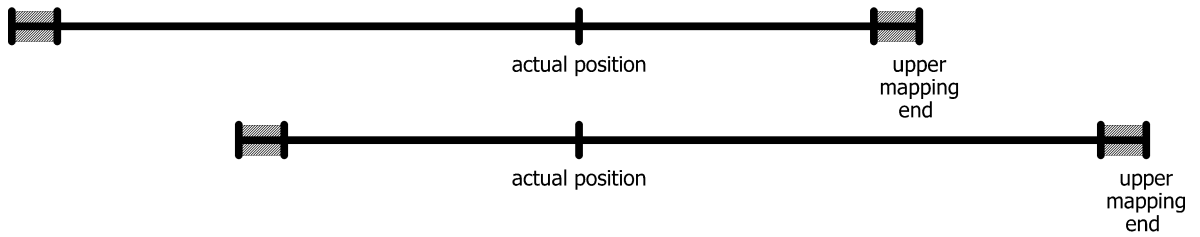

5) Setting upper and lower limits:

If necessary, the maximum possible positioning range can be restricted to prevent incorrect target positions that lead to a collision.

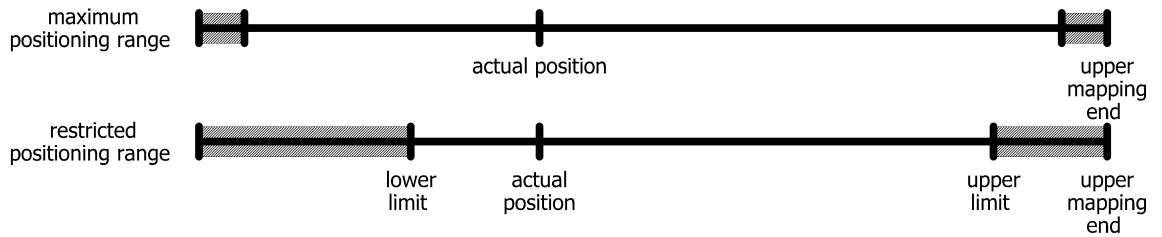

**5.7. Using actual value assessment factors to set the spindle pitch**

The PSE object; class 100, instance 1, attribute 16 (numerator factor) and attribute 17 (denominator factor) can be used to represent any desired spindle pitch.

Both factors are set to a value of 400 by default, resulting in a resolution of 0.01 mm at a spindle pitch of 4 mm.

The denominator factor serves as a simple means of setting the spindle pitch and resolution.

The numerator factor is primarily used for setting "uneven" resolutions.

Examples:

Spindle pitch	Resolution	Numerator factor	Denominator factor
4 mm	1/100 mm	400	400
1 mm	1/100 mm	400	100
2 mm	1/10 mm	400	20

Numerator and denominator factors may take on values between 1 and 10,000.

**5.8. Drag error**

During a positioning run, the device compares the computed target position with the current actual value. If the difference is larger than the "drag error" value (PSE object; class 100, instance 1, attribute 5), the device sets the corresponding bit in the status word. This applies in particular if the target speed cannot be achieved due to external influences (required torque, motor voltage too low).

## 5.9. Aborted run when the master fails

If the connection to the master is interrupted during a positioning run, the master cannot abort a run that is already in progress. Automatically aborting a run in this case requires an I/O connection with an expected packet rate greater than 0; this connection must be set up in advance and used for initiating the positioning run. Poll I/O and bit-strobe I/O may be considered for this connection. Another option would be to set up a change-of-state/cyclic connection with master acknowledge and an expected packet rate greater than 0. In this case, the run could be aborted regardless of how the positioning run had been initiated (i.e., even when using an explicit connection).

## 5.10. Optional: Manual run using external keys (jog key mode)

A manual run can be performed using external keys under the following conditions:

- 1) when the CAN bus is not connected and the address 99 is set with the help of the address switches
- 2) when the CAN bus is connected and in the control word bit 5 is active ('release for jog key mode') and bit 4 is inactive ('release for positioning by bus')

Altogether there's the following assignment:

CAN bus connected	address	control word bit 4	control word bit 5	external keys
no	0..98	X	X	inactive
no	99	X	X	active
yes	X	X	0	inactive
yes	X	1	X	inactive
yes	X	0	1	active

Bit 5 ('release for jog key mode with the external keys') and bit 4 ('release for positioning by bus') cannot be set simultaneously. Changing the release while running (for example from jog key mode to positioning by bus) aborts a run in the other operation mode.

The operator can adjust the number of increments for a single step via attr. 34. The single step is being executed if one of the external keys is being pressed. If the external key has been released before the end of the single step, it will be completed nevertheless. If the external key stays pressed further on, after a short waiting time a continuous manual run might join the single step under some circumstances. This continuous manual run will run as long as the external key stays pressed. The continuation of a single step with a manual run is always enabled if the CAN bus is not active. If the CAN bus is active, additionally to bit 5 of the control word also bit 3 ('release for manual run in jog key mode') has to be activated. If bit 3 is not set, each pressing of the external key results in a single step, even if the key is pressed longer than the duration of the single step.

The idle period before the drive switches into manual run is specified with attr. 35. In manual run the drive runs maximum to the specified limit switch position (attr. 22 resp. 23).

If during an jog run both external keys are pressed, the run is aborted immediately. A new jog run is only possible if both keys are released.

To prepare the function of the external keys, the corresponding key contact (pin 2 or 3 of the 4-pin plug) must be connected with +24V (pin 1). If the key signal is generated by a voltage source which is galvanically separated from the internal voltage source of the drive, GND (pin 4) must be connected.

Jog runs without external keys:

Jog runs are also possible without external keys. For this purpose bit 8 ('jog run to larger values') and bit 9 ('jog run to smaller values') are provided, these bits simulate the pressing of the corresponding external keys.

Requirement: Bits 4 and 5 of the control word have to be reset.

### 5.11. Manual turning with the adjustment facility

When mounting or dismounting a PSx3xx, it may be necessary to manually turn the output shaft to a certain position. For this purpose, the actuators are equipped with a manual adjustment facility:

First, the corresponding cover in the cover must be removed.

Then use a NW3 (PSx31x, PSx33x, or NW4 (PSx30x, PSx32x) hexagon key to disengage the brake by pressing it down and turn it simultaneously.

An electrical release of the brake via bus is not possible on its own (without travel job).

#### CAUTION

The drive must not be turned into another position with an electric screwdriver.

#### CAUTION

Important: Always replace the protective cap after setting the address. This will prevent dust and contaminants from entering the instrument.

#### CAUTION

A "forced" turning of the drive without disengaging the brake leads to the destruction of the brake and thus of the drive!

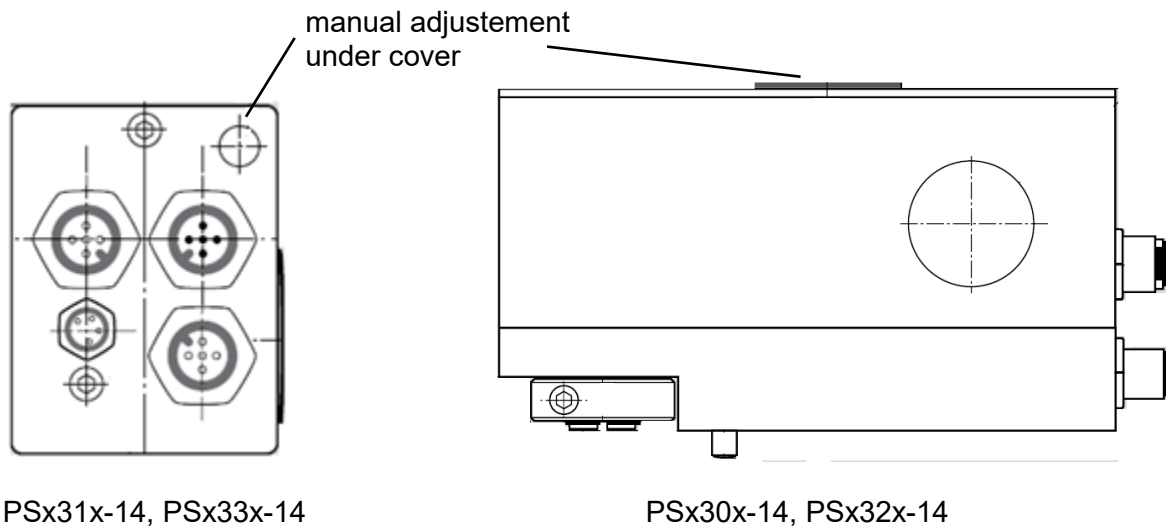

### 5.12. Devices with optional holding brake

The device models PSx30xDN-14, PSx31xDN-14, PSx32xDN and PSx33xDN can be supplied with an optional holding brake. This brake prevents the output shaft from turning when the power supply to the motor is removed, or, if the motor holding torque is too low, to a maximum of the level of the nominal torque. A small degree of rotation always occurs at the output, i.e. the brake cannot be used to hold the drive at a defined position (for this purpose where appropriate the holding torque might be increased with the help of attr. 43 and attr. 153).

To release the brake when a run command is transmitted, these devices first wait for a short time (by default 0.15 sec before beginning the run, attr. 146) and then run a few increments against the actual direction of movement (number of increments: attr. 147). The brake is closing at the end of every run (by default 1 sec after the end of the run, attr. 69). The advantage of this feature is, that in case of many subsequent runs the brake has not to be released anew each time.

To adjust the position of the drive manually, it is first necessary to remove the rubber-plug in the top cover (see drawings at the end of these instructions). Then release the brake by pressing down and simultaneously turning using a hex wrench NW3 (PSx31xDN and PSx33xDN) or NW4 (PSx30xDN and PSx32xDN).

### 5.13. Devices with optional friction brake

The device model PSE34xxDN can be supplied with an optional friction brake. This brake prevents the output shaft from turning when the power supply to the motor is removed, or, if the motor holding torque is too low.

A run command is not approached immediately but only after a short idle period to tighten the brake.

The brake releases at the end of every run.

To adjust the drive manually, it is first necessary to remove the corresponding rubber-plug in the top cover (see drawings at the end of these instructions). The drive can then be rotated using a hex wrench NW4. This is quite difficult as the operator has to overcome both any torque present at the output and the force of the friction brake.

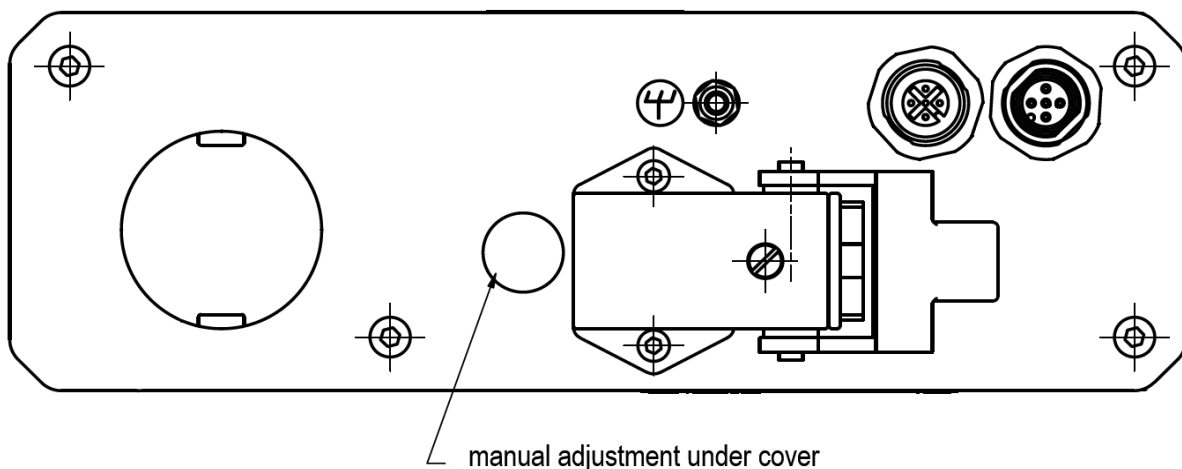

## 5.1. Reference runs

The PSx3xxDN positioning system is equipped with an absolute measuring system, therefore there's no need for a reference run when powering on the drive. However, if in certain cases a reference run onto a hard block should be desired (e.g. uniquely when installing the drive at a machine), the course of action should be the following:

- 1) Before commanding the reference run the following settings have to be carried out:
  - set the maximum torque (attr. 20) and the maximum start-up torque (attr. 24) to max. 10% of the nominal torque
  - set the maximum holding torque (attr. 43) and the maximum holding torque at end of run (attr. 153) to 0
  - set the rpm limit for aborting run (attr. 26) to 60
  - set the time elapsed until speed falls below rpm limit for aborting run (attr. 27) to 100 (The span of time in which the drive tries to get over the block, decreases: With the reduced values the positioning will be aborted if the speed stays below 60% of the target speed for longer than 100ms. By default, these values are 30% and 200ms.)
  - set the corresponding upper and lower limit (attr. 22 or 23) in a way that the block location lays considerable within the area between the upper and lower limit (Otherwise there's the danger that the block is located within the positioning window and consequently won't be recognized.)
  - Where appropriate, reduce the target speed for manual run (attr. 19).
- 2) Now start the reference run as manual run (set bit 0 or 1 in the control word).
- 3) Wait for the drive moving (bit 6 in the status word is set).
- 4) Wait for the drive has stopped and a positioning error has appeared (bit 6 in the status word is cleared, bit 10 is set).
- 5) Start a manual run in the opposite direction with the same settings (move a certain distance away from the hard stop in order the drive can move freely).
- 6) Only now adjust the desired settings of the adove mentioned attributes for normal operation.

## 5.2. Reverse drive

In vertical positioning with spherical roller spindles, pitches of approx. 4..10 mm and weights from 100 kg, it is possible that the PSx3xx does not consume any energy from the motor supply when travelling downwards, but rather generates some. This regenerative operation is permissible under certain conditions. The energy generated is fed back into the motor supply network via the internal regenerative circuit and must be drawn off there. The PSx3xx increases the voltage in the motor supply network until the additional energy is drawn off. However, the internal protection diode limits this voltage to max. 31 VDC.

The following cases should be considered:

- 1) If several PSx3xx and/or other loads are connected to the same power supply, regeneration is possible without any additional measures if several PSx3xx do not generate power simultaneously. The other devices then act as consumers of the energy generated by a PSx3xx.
- 2) If several PSx3xx are to use the regenerative circuit simultaneously, an overvoltage protection must be provided in the motor supply network.

If a PSx3xx is operated for more than 1-2 seconds in regenerative mode without consumer of the generated energy, this damages the internal protection diode and the PSx3xx is defective.



## 6. Technical data

### 6.1. Ambient conditions

ambient temperature	0 °C to +45 °C		
storage temperature	-10 °C to +70 °C		
shock resistance according to DIN IEC 68-2-27	50 g 11 ms		
resistance to vibration according to DIN IEC 68-2-6	10 Hz to 55 Hz 1.5 mm 55 Hz to 1000 Hz 10 g 10 Hz to 2000 Hz 5 g		
EMC standards	CE		
conformity	CE / UKCA		
protection class	PSE	IP 54 / IP 65	
	PSS	IP 65	
	PSW	IP 66 (in operation) IP 68 (at standstill)	
duty cycle	Device model	Duty cycle in %	Base time in sec.
	PSE34xx	20	300
	PSE30xx to 33xx	30	300
	PSS	20	600
	PSW	20	600

### 6.2. Electrical data

nominal power output	PSx30x, PSx31x, PSE31xx	25 W with 30 % duty cycle
	PSx32x, PSx33x	35 W with 30 % duty cycle
	PSE34xx	100 W with 20 % duty cycle
supply voltage	24 VDC ±10 % (supply voltages for motor and control unit are galvanically isolated) advice: use regulated power supplies	
nominal current, control unit	0.15 A	
nominal current, motor	PSx30x, PSx31x, PSE31xx	2.4 A
	PSx32x, PSx33x	3.1 A
	PSE34xx	7.8 A
positioning resolution	0.9°	
positioning accuracy	0.9°	
CAN protocol	DeviceNet (ODVA CIP Networks Library Volume One Edition 3.1 and Volume Three Edition 1.3) <u>CAN address setting via decade switch/bus:</u> addresses 0...63 <u>baud rate setting via sliding switch/bus:</u> 125 kBaud, 250 kBaud, 500 kBaud (CAN address and baud rate setting for software versions starting from version 147) In some stainless steel variants (e.g. the PSx395RD) the protective cap is not present. In this case, device address and baud rate can only be set via bus!	
absolute value acquisition	optical - magnetic	

### 6.3. Physical data

positioning range	250 usable rotations, no mechanical limits measuring system has a span of 256 turns, minus 3 turns security stock at upper and lower range limit	
torsional rigidity (angle of rotation when switching from operation without backlash to maximum torque)	max. 0.2°	
gear backlash (without spindle compensation run)	max. 0.5°	
spindle lash compensation	automatic loop after every positioning run (may be deactivated)	
output shaft	PSE30x-8 PSE31xDN-8	8H9 hollow shaft with adjustable collar
	PSE30x-14, PSE31x-14, PSE32x, PSE33x	14H7 hollow shaft with adjustable collar
	PSE31xx-14 PSE34xx	14H7 hollow shaft with clamp and feather key
	PSS3xx-8 PSW3xx-8	8H9 hollow shaft with adj. collar or 8h8 solid shaft
	PSS3xx14 PSW3xx-14	14H7 hollow shaft with adj. collar or 14h8 solid shaft
recommended diameter of the spindle head	according to the hollow shaft diameter with an interference fit of h9	
Vibration emission	not in the harmful range	
Noise emission	not in the harmful range	
maximum radial force	40 N	
maximum axial force	20 N	
dimensions (l x w x h)	see catalog data on our website	
weight (approx.)	PSx30x-8	650 g
	PSx30x-14, PSx32x	1200 g
	PSx31x-8	700 g
	PSx31x-14, PSx33x	700 g
	PSE31xx	1200 g
	PSE34xx	1900 g

For additional specifications and dimension drawings, please visit our website at  
<https://www.halstrup-walcher.de/en/products/drive-technology/>



## 7. Certificate of Conformity



### EU-Konformitätserklärung EU Declaration of Conformity

<b>Company</b>	<b>halstrup-walcher GmbH, Stegener Str. 10, 79199 Kirchzarten</b> erklärt als Hersteller in alleiniger Verantwortung, dass das Produkt declares as manufacturer under sole responsibility, that the product
<b>Product</b>	<b>Positionierantriebe Baureihen PSE3xx, PSS3xx, PSW3xx</b> <b>Positioning Systems Series PSE3xx, PSS3xx, PSW3xx</b>
<b>Regulations</b>	den folgenden Europäischen Richtlinien entspricht: conforms to following European Directives: EMC 2014/30/EU RoHS 2011/65/EU
<b>Standards</b>	angewandte harmonisierte Normen: applied harmonized standards: EN IEC 61800-3:2018 EN IEC 63000:2018
<b>Certification</b>	EU Konformitätserklärung ausgestellt von EC Type Examination Certificate issued by

Geschäftsführer

Managing Director

Kirchzarten,

14. Okt. 2020

14. Oct. 2020

halstrup-walcher GmbH  
Stegener Straße 10  
79199 Kirchzarten

Telefon: +49 (0) 7661 3963-0  
Fax: +49 (0) 7661 3963-99  
E-Mail: [info@halstrup-walcher.de](mailto:info@halstrup-walcher.de)

Geschäftsführer: Jürgen Walcher, Christian Sura  
Handelsregister Freiburg HRB 2209  
Umsatzsteuer-ID-Nr. DE 811159901



## UK Declaration of Conformity

**Company** halstrup-walcher GmbH, Stegener Str. 10, 79199 Kirchzarten, Germany

declares as manufacturer under sole responsibility, that the product

**Product** Positioning System Models PSE3xx / PSS3xx / PSW3xx

**Regulations** is in conformity with relevant statutory requirements:

EMC Electromagnetic Compatibility Regulations 2016 No. 1091  
RoHS RoHS Regulations 2012 No. 3032

**Standards** applied standards:

EN 55011:2016+A1:2017; EN 61000-6-2:2005; EN 61800-3:2004/ A1:2012  
EN IEC 63000:2018

**Declaration** signed for and on behalf of



Geschäftsführer

Managing Director

Kirchzarten, 26. Jan. 2022

halstrup-walcher GmbH  
Stegener Straße 10  
79199 Kirchzarten

Telefon: +49 (0) 7661 3963-0  
Fax: +49 (0) 7661 3963-99  
E-Mail: info@halstrup-walcher.de

Geschäftsführer: Jürgen Walcher, Christian Sura  
Handelsregister Amtsgericht Freiburg HRB 2209  
Umsatzsteuer-ID-Nr. DE 811169901





